

BIOS1 24V

CONTROL UNIT FOR SLIDING
GATES AT 24V

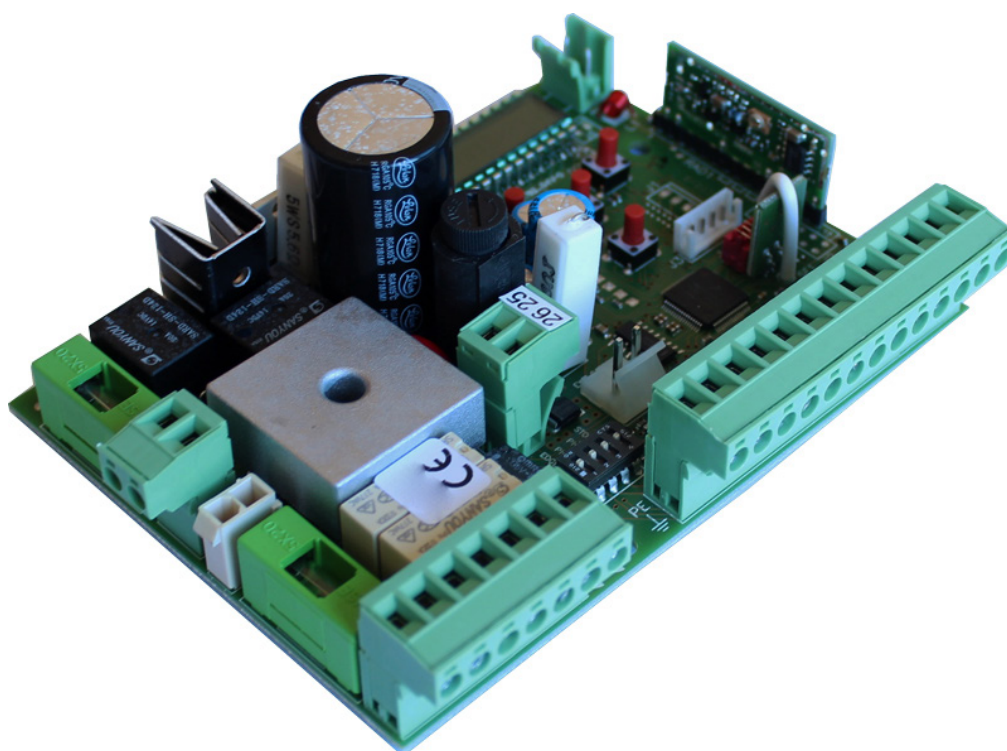

 **ALLMATIC**[®]

MADE IN ITALY



UK CA CE

1 - GENERAL WARNINGS

! WARNING! Before installing the product, it is mandatory to read the document relating to **GENERAL SAFETY WARNINGS** supplied with the product. Document **6-1620001**.
The supplementary sheet can also be downloaded from www.allmatic.com.

2 - SELECTION OF THE MOTOR

! WARNING! Before executing the learning of the strokes, the memorization of the transmitters and before performing any other setting, it is necessary to select the motorization in use, this allows to optimize the operation of BIOS1 24.
ACCESS TO THE ADVANCED MENU VOICE dE.F., select the value corresponding to the motor to be controlled and perform a reset by completing the countdown on the display. Refer to the table on page 20.
The procedure is as follows, in the example the KALOS XL motor is selected (1):

WARNING! The procedure performs a restoration of the factory values causing the loss of any customizations. It does not affect the amplitude of the programmed strokes and the memorized transmitters.

| | |
|---|---|
| 0 | OTHER MOTORS (EXECUTE NECESSARY PERSONALIZATIONS) |
| 1 | KALOS XL / MOVEO |
| 2 | KALOS 70 |
| 3 | KALOS 110 |
| 4 | SIM |
| 5 | KALOS XL FAST |

ENG

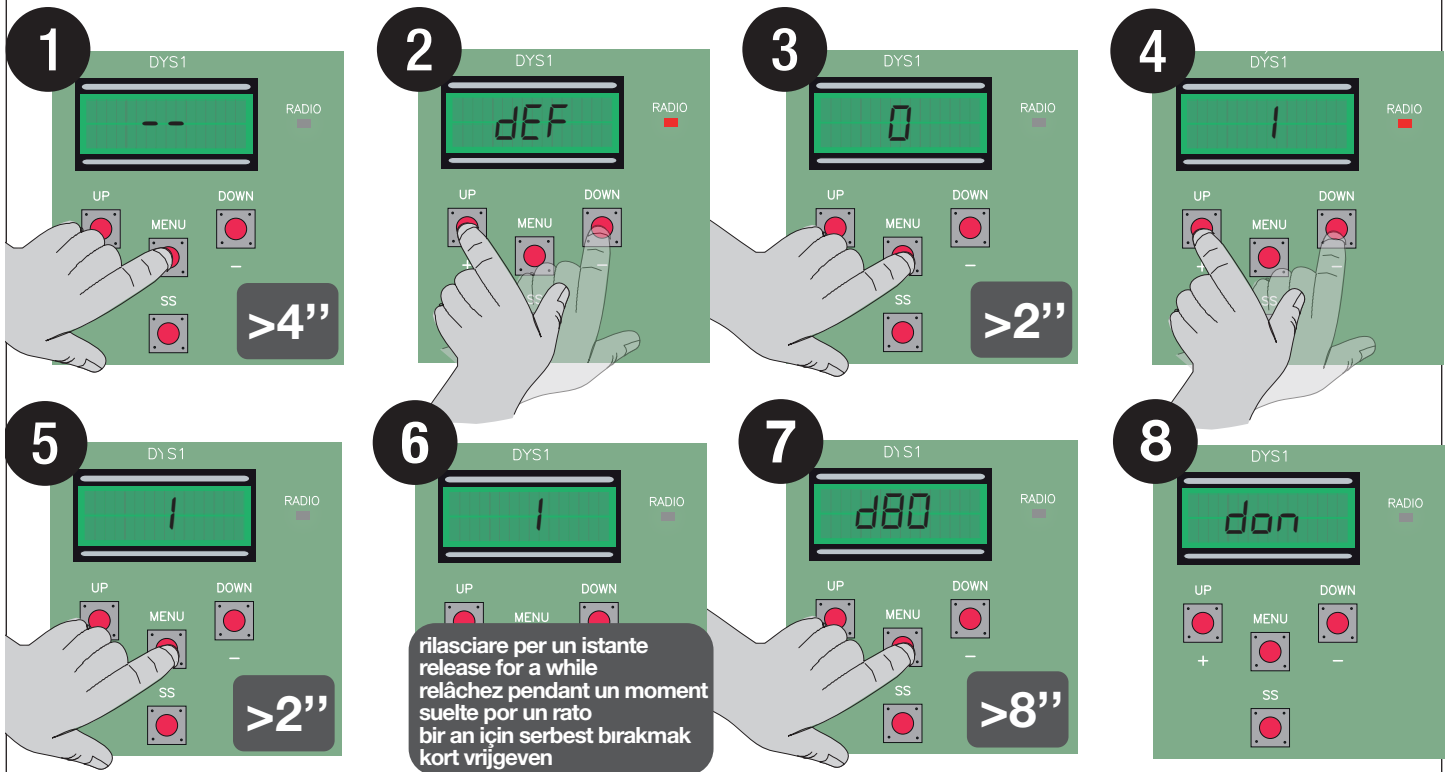

3 - PRODUCT DESCRIPTION

The control unit BIOS1 24V is suitable for the installations of 1 motor with direct current 24V and a maximum absorption of 10A. This device has an easy and intuitive functioning thanks to the display interface and 4 buttons. The control unit allows a precise regulation of all parameters. The control unit can memorize up to 1000 transmitters (external memory) with the step by step, partial opening, open and close functions. It is supplied with inputs for opening and closing photocells, safety edge (mechanical or resistive), opening/closing limit switches and buttons for step by step, partial opening, open, close and stop. The outputs include a 24 Vac flashing light, 24Vac courtesy light/open automation light and 24 Vdc accessories power supply. Buffer batteries use is available in case it would be necessary to assure the temporary service in case of lack of power.

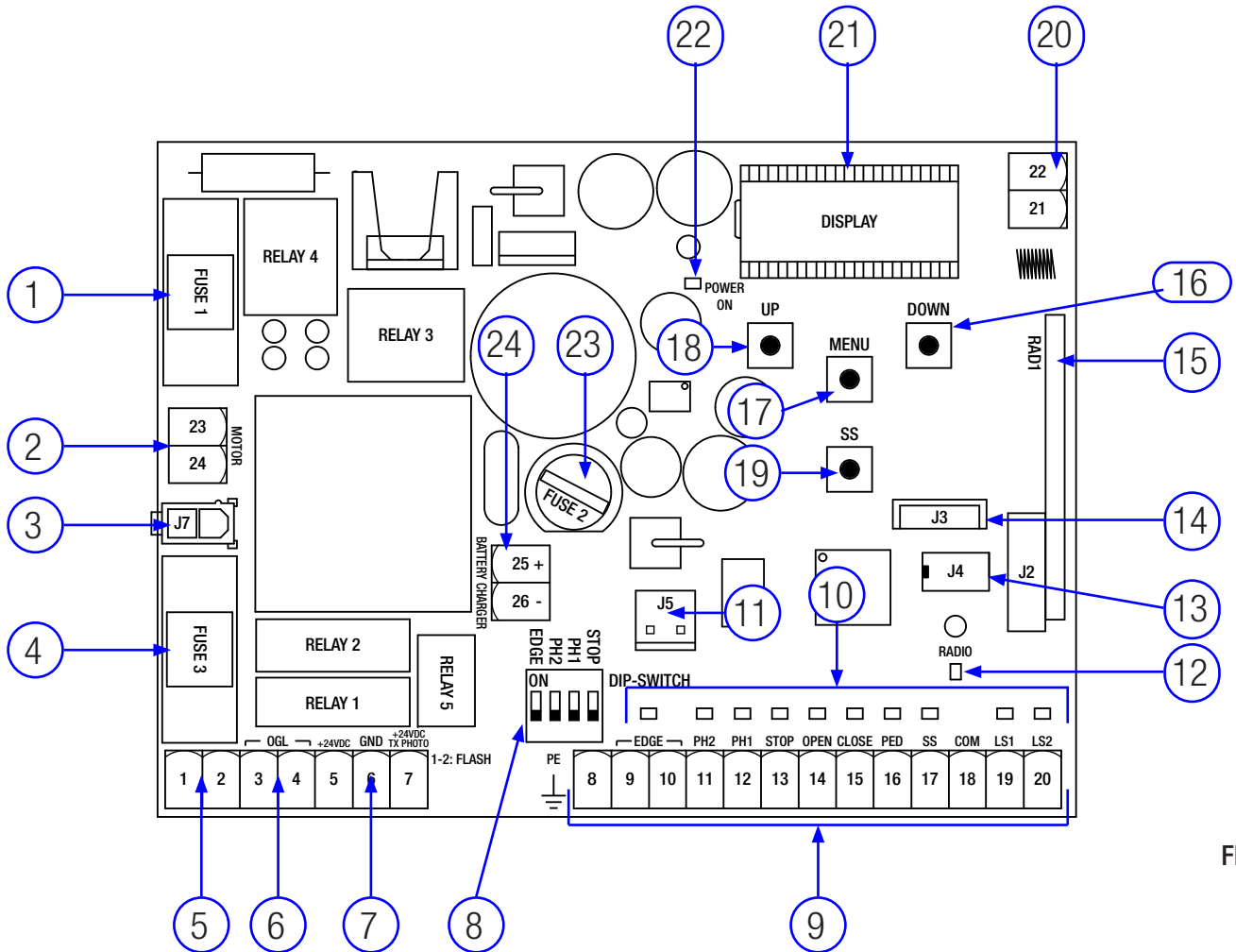

FIG. 1

3.1 - MAIN COMPONENTS / CONNECTIONS

- | | |
|---|--|
| <ol style="list-style-type: none"> 1. Fuse 1: T 10A fuse for motor protection. 2. Connection for motor power supply. 3. Connection for transformer. 4. Fuse 3: T 2,5A fuse for 24Vac outputs protection. 5. Connection for flashing light 6. Connection for courtesy light / open automation light. 7. Connection for photocells power supply and 24Vdc accessories. 8. DIP-SWITCH for safety devices 9. Connection for command and safety devices. 10. Signaling Led for the inputs state. 11. Connector for optional R1 card. 12. Signaling Led for the radio signal. | <ol style="list-style-type: none"> 13. Connector for external memory. 14. Connector for Bluetooth module. 15. Connector for radio module. 16. Button DOWN -. 17. Button MENU. 18. Button UP +. 19. Button Step-by-Step (SS). 20. Connection for antenna. 21. Display. 22. Led for the presence of the power supply. 23. Fuse 2: F200mA fuse for 24Vdc protection. 24. Connection for the batteries charger card. |
|---|--|

ENG

3.2 - MODELS AND TECHNICAL FEATURES

| CODE | DESCRIPTION |
|----------|---|
| 12006685 | BIOS1 24V control unit for a single motor |
| 60550058 | Transformer 230 / 23 Vac 150VA |
| 12006730 | Bluetooth module |
| 12000760 | R1 card |
| 12000780 | Battery charger 24CBA card |

| | |
|---|----------------|
| Transformer power supply | 230Vac 50-60Hz |
| Fuse for transformer protection | T 1A |
| BIOS1 24V power supply | 24Vac 50-60Hz |
| Maximum power of the motor output | 240W |
| Flashing light output | 24Vac 25W |
| Courtesy light / Open automation light output | 24Vac 25W |
| 24Vdc accessories power supply | 24Vdc 5W |
| 433MHz radio receiver | Rolling Code |
| Memorisable transmitters | 1000 |
| Operating temperature | -10°C +55°C |

3.3 - LIST OF THE SUGGESTED CABLES

The suggested cables for the connection of the various devices in a standard system are listed in the following list. The used cables must be suitable for the type of installation; for example, an H03VV-F type cable is recommended for indoor applications, while H07RN-F is suitable for outdoor applications.

| Connection | Cable | Maximum length |
|--|-------------------------|----------------|
| Line for the power supply | 3 x 1,5 mm ² | 20 m * |
| Motor | 2 x 1,5 mm ² | 20 m * |
| Flashing light | 2 x 0,5 mm ² | 20 m |
| Courtesy light / Open automation light | 2 x 0,5 mm ² | 20 m |
| Photocells - transmitter | 2 x 0,5 mm ² | 20 m |
| Photocells - receiver | 4 x 0,5 mm ² | 20 m |
| Safety edge | 2 x 0,5 mm ² | 20 m |
| Key selector | 4 x 0,5 mm ² | 20 m |

* If the cable is more than 20 m long, it must be of larger gauge and a safety grounding system must be installed near the automation unit.

3.4 - PRELIMINARY CHECKS

- The gate shall move frictionless.

Note: Gate features must be uniformed with the standards and laws in force. The door/gate can be automated only if it is in a good condition and if its conditions comply with the EN 12604 norm.

- The door/gate leaf should not have a pedestrian opening. In the opposite case it is necessary to take the appropriate steps, in accordance with EN 12453 norm (for instance: by preventing the operation of the motor when the pedestrian opening is opened, by installing a safety microswitch connected with the control panel).

- Besides the electrical or mechanical limit switches available on the operators, there must be, on both ends of the installation, a fixed mechanical stopper which stops the gate in the unlikely event of bad functioning of the limit switches on the operators. For this reason the fixed mechanical stopper must be of an adequate size to withstand the static and kinetic forces generated by the gate (A) (Fig.2).

The guide must be provided with two mechanical stops at its ends (A) (Fig. 2).

- The gate columns shall have anti-derailment guides on their top (Fig. 3),

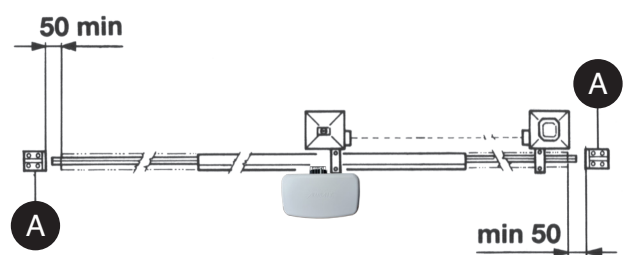

FIG. 2

to avoid the unintentional gate release.

Note: Eliminate the mechanical stops of the kind described by Fig. 3. No mechanical stop shall be on top of the gate, since mechanical stops are not safe enough.

| Parts to install meeting the EN 12453 standard | | | |
|---|---------------------------------------|-------------------------------|------------------|
| COMMAND TYPE | USE OF THE SHUTTER | | |
| | Skilled persons (out of public area*) | Skilled persons (public area) | Unrestricted use |
| with manned operation | A | B | non possible |
| with visible impulses (e.g. sensor) | C or E | C or E | C and D, or E |
| with not visible impulses (e.g. remote control) | C or E | C and D, or E | C and D, or E |
| automatic | C and D, or E | C and D, or E | C and D, or E |

* a typical example are those shutters which do not have access to any public way
 A: Command button with manned operation (that is, operating as long as activated).
 B: Key selector with manned operation.
 C: Adjustable power of the motor.
 D: Safety strips and/or other safety devices to keep thrust force within the limits of EN12453 regulation - Appendix A.
 E: Photocells.

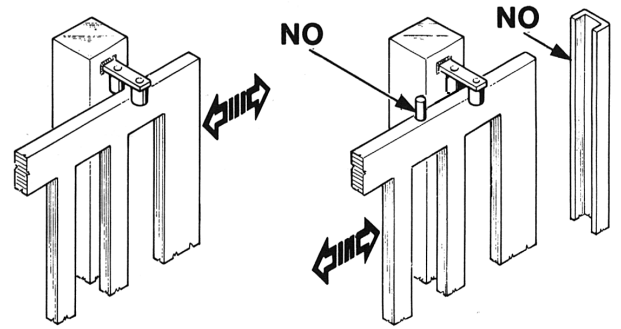

FIG. 3

WARNING - Before making the connections, be sure that the control unit is not powered up.

DIP-SWITCH FOR SAFETY DEVICE: Set on "ON" to disable inputs EDGE, PH2, PH1 AND STOP. Eliminates the need to bridge the terminal board inputs.

WARNING - with the dip switch ON, the safety devices are disabled

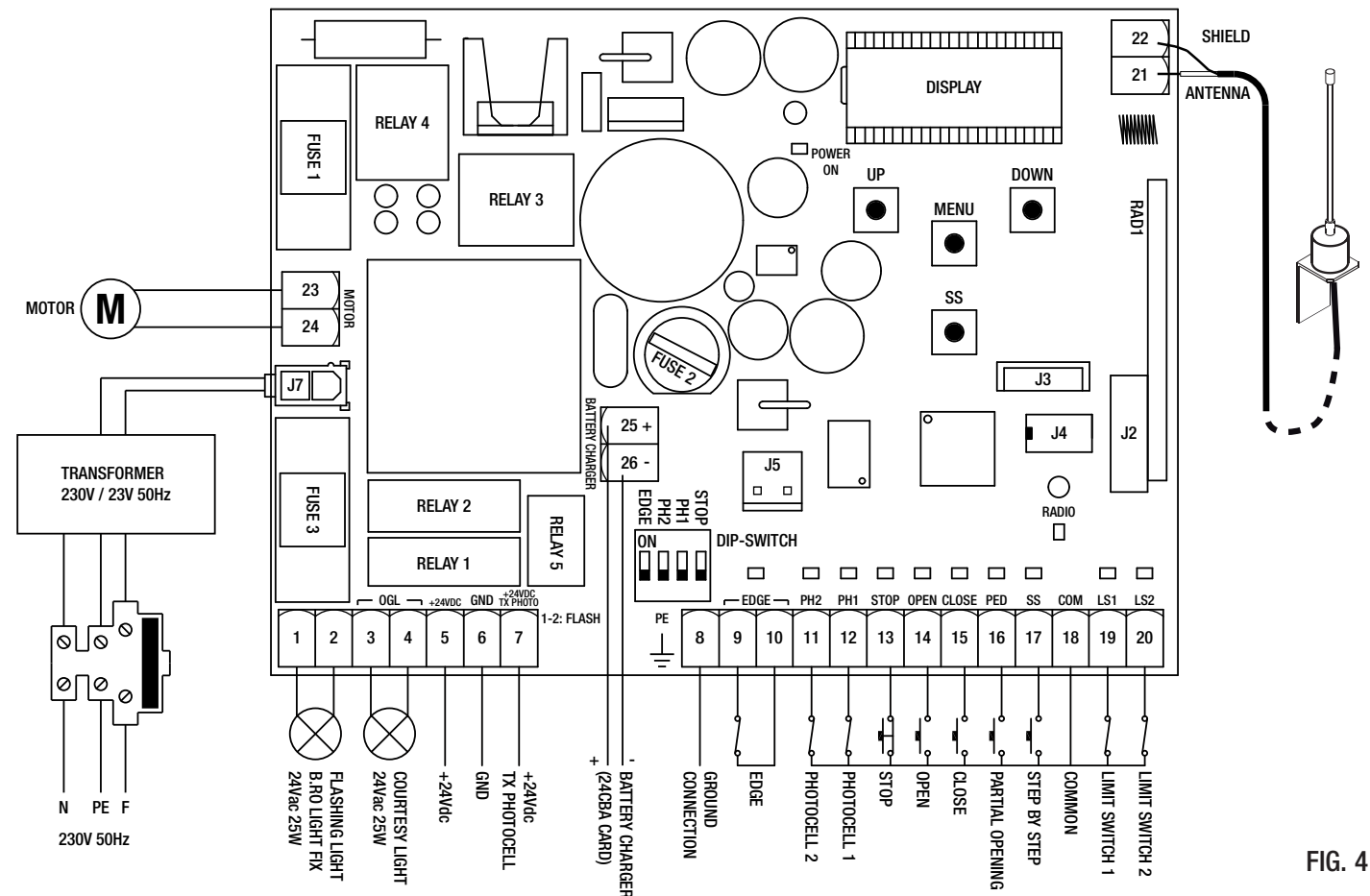

FIG. 4

ENG

4.1 - LIST OF TERMINAL BOARDS AND CONNECTORS

| Number | Name | Description |
|---------|-----------------|---|
| 1 - 2 | FLASH | Flashing light output at 24Vac. Use a flashing light without self flashing card 24Vac 25W max. |
| 3 - 4 | OGI | Courtesy light / Open automation light output at 24Vac. Use a light 24Vac 25W max. The functioning of the auxiliary light and its activation time are managed from advanced items <i>F.C.3.</i> and <i>E.C.3.</i> |
| 5 | +24VDC | +24Vdc accessories power supply. Used for the receiver of the photocells. |
| 6 | GND | 0Vdc accessories power supply. WARNING - The control unit supplies up to a maximum of 200 mA (5W) for the accessories at 24Vdc. |
| 7 | +24VDC TX PHOTO | +24Vdc accessories power supply. Used for the transmitter of the photocells. This connection is necessary in case of use of the photocells test. It is possible to enable the photocells test from the advanced menu <i>E.P.h.</i> |
| 8 | PE | Ground connection. |
| 9 - 10 | EDGE | Safety edge input (NC contact). Select the type of the used safety edge (mechanical or resistive) through the advanced menu <i>E.d.1.</i> and the mode of intervention with the advanced menu <i>i.E.d.</i> WARNING - with DIP EDGE on "ON" the input is disabled. |
| 11 - 18 | PH2 - COM | Opening photocell input (NC contact). The photocell intervenes at any time during the opening of the automation system and stops immediately the movement; the automation system will continue the opening when the photocell beam is freed. In the event of intervention on closure (parameter Ph.2. = 0), the automation stops and, when the beam is freed, moves on opening. In the advanced item <i>P.h.2.</i> , it is possible to select the behaviour of the photocell. WARNING - with DIP PH2 on "ON" the input is disabled. |
| 12 - 18 | PH1 - COM | Closing photocell input (NC contact). The photocell intervenes at any time during the closing of the automation system, stops immediately and inverts the movement. The photocell doesn't intervene during the opening. In the advanced item <i>S.P.h.</i> it is possible to select the behaviour of the photocell with the closed automation. WARNING - with DIP PH1 on "ON" the input is disabled. |
| 13 - 18 | STOP - COM | Connect the STOP command (NC contact). This input is classified as a safety device; the opening of the contact stops immediately the automation and it remains blocked up to the restoring of the state of the input contact. WARNING - with DIP STOP on "ON" the input is disabled. |
| 14 - 18 | OPEN - COM | Connect the button for the OPEN command (NO contact). |
| 15 - 18 | CLOSE - COM | Connect the button for the CLOSE command (NO contact). |
| 16 - 18 | PED - COM | Connect the button for the PARTIAL OPENING command (NO contact). |
| 17 - 18 | SS - COM | Connect the button for the STEP-BY-STEP command (NO contact). |
| 18 | COM | Common for safety and command inputs. |
| 19 - 18 | LS1 - COM | Connect the limit switch 1 (NC contact). |
| 20 - 18 | LS2 - COM | Connect the limit switch 2 (NC contact). |
| 21 | ANTENNA | Connect the antenna |
| 22 | SHIELD | Connect the antenna braiding. |
| 23 - 24 | MOTOR | Connect the motor. |
| 25 - 26 | BATTERY CHARGER | Connect the battery charger card. Use the clamp 25 for the POSITIVE pole. Use the clamp 26 for the NEGATIVE pole. |
| J3 | | Connector for the Bluetooth module. |
| J4 | | Connector for the external memory. |
| J5 | | Connector for the optional R1 card. |
| J7 | | Connector for the power supply from the transformer. |

5 - DISPLAY AND STATES OF THE CONTROL UNIT

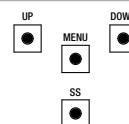

By pressing the "DOWN" button it is possible to read on the display the following parameters.

| DISPLAY | DESCRIPTION |
|--|---|
| State showing (-- , <i>OP</i> , <i>CL</i> , ...) | Description of the control unit state. Refer to the STATES OF THE CONTROL UNIT table for the description of the single states of functioning. |
| Maneuvers performed, e.g.: <i>02.0.</i> (unit) / <i>00 1</i> (thousand), that is 1020 cycles. | Maneuvers count: the display shows alternately the thousands (without dots) and the units (with dots). |

5.1 - STATE OF THE CONTROL UNIT

| DISPLAY | DESCRIPTION |
|------------|---|
| -- | Standby - Automation closed or after the switch on of the control unit. |
| <i>OP</i> | Opening phase. |
| <i>CL</i> | Closing phase. |
| <i>SO</i> | Automation stopped by the user during the opening. |
| <i>SC</i> | Automation stopped by the user during the closing. |
| <i>HA</i> | Automation stopped by an external event (photocells, stop). |
| <i>oP</i> | Automation opened without automatic reclosing. |
| <i>PE</i> | Automation opened on partial opening position without automatic reclosing |
| <i>-tc</i> | Automation opened with auto reclosing; in the last 10 seconds the dash will be replaced by the countdown. |
| <i>-tP</i> | Automation opened on partial opening position with auto reclosing; in the last 10 seconds the dash will be replaced by the countdown. |

| DISPLAY | DESCRIPTION |
|--------------|---|
| <i>rAd</i> | Visualized during the learning of transmitters. |
| <i>don</i> | Visualized when a new transmitter is memorized or at the end of a reset |
| <i>Fnd</i> | Visualized when a key of a transmitter already memorized is stored. |
| <i>CLr</i> | Visualized when a transmitter is erased. |
| <i>LOP</i> | Visualized during the learning of strokes to indicate that the control unit is opening the automation. |
| <i>LCL</i> | Visualized during the learning of strokes to indicate that the control unit is closing the automation. |
| <i>L--</i> | Visualized during the learning of strokes if there is an intervention of safety devices. |
| <i>SEE</i> | Visualized when the control unit waits for a transmitter signal, during the function of viewing of the memory location. |
| <i>not</i> | Visualized when the transmitter is not stored on the memory, during the function of viewing of the memory location. |
| <i>toUt</i> | Visualized when the control unit exits from the function of viewing of the memory location for inactivity. |
| <i>Snd</i> | Visualized during the first coupling with the Bluetooth device. |
| <i>c --</i> | Visualized when the control unit is connected to a Bluetooth device. |
| <i>L --</i> | Visualized when the Bluetooth device is disconnecting from the control unit. |
| <i>Power</i> | Visualized when the power supply is not enough. |

ENG

5.3 - MALFUNCTION SIGNALLINGS

| DISPLAY | DESCRIPTION |
|------------|--|
| <i>E7E</i> | Memory error: the external memory not installed or not recognised. |
| <i>EEx</i> | Memory error during the writing: the value x is a number from 1 to 6. In the event of the error, contact the technical assistance. |
| <i>ELS</i> | Limit switches error: opening and closing limit switches are busy in the same time |
| <i>EFO</i> | Impact sensor intervention. |
| <i>EEd</i> | Safety edge intervention. |
| <i>EPH</i> | Malfunctioning of photocells. |
| <i>Eth</i> | Thermal intervention to preserve the control unit. |
| <i>FUL</i> | Full external memory. |
| <i>Err</i> | Memory error during functions viewing memory location or cancellation of a single transmitter. |

NOTE - The visualization of an error on the display persists until the "DOWN" button is pressed or until another command is given.

WARNING - the restore from an EEx error must be carried out through one of the 3 buttons of the control unit (UP, MENU or DOWN).

! **WARNING!** If the supply fuse blows with the motor blocked, check the intervention thresholds of the current sensor. A correct configuration of the SEN and SEL parameters limits the possibility of failure of the power supply fuse. To avoid the intervention of the supply fuse in the condition of motor block it is advisable to use the inversion function on the obstacle.

5.4 - SIGNALLING LED

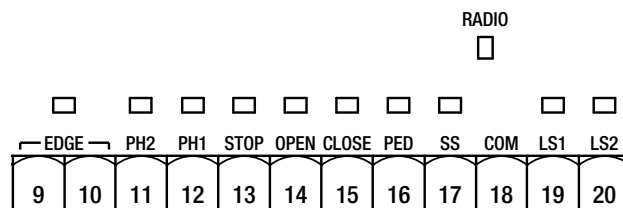

FIG. 5

| LED | COLOUR | DESCRIPTION |
|----------|--------|---|
| EDGE | RED | Safety signalling, Led normally ON. |
| PH2 | RED | Safety signalling, Led normally ON. |
| PH1 | RED | Safety signalling, Led normally ON. |
| STOP | RED | Safety signalling, Led normally ON. |
| OPEN | GREEN | Led normally OFF. It is turned on when the button is pressed. |
| CLOSE | GREEN | Led normally OFF. It is turned on when the button is pressed. |
| PED | GREEN | Led normally OFF. It is turned on when the button is pressed. |
| SS | GREEN | Led normally OFF. It is turned on when the button is pressed. |
| LS1 | RED | Led is turned on when the limit switch is not activated. |
| LS2 | RED | Led is turned on when the limit switch is not activated. |
| RADIO | RED | Led ON with a radio transmission or interferences. |
| POWER ON | GREEN | Led normally ON. It shows the presence of the power supply. |





6 - REMOTE CONTROL LEARNING

The learning of a transmitter can be enabled with the "UP" button of the control unit or with the hidden key of a transmitter already memorized. The BIOS1 24V control unit can memorize up to 4 functions in as many keys of the remote control. During the learning procedure, described at paragraph 6.1, a single key is stored. So, it will be necessary to carry out up to 4 learnings for the assignment of all possible functions.

The functions will be assigned following the order below:

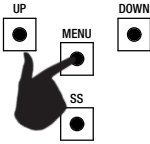
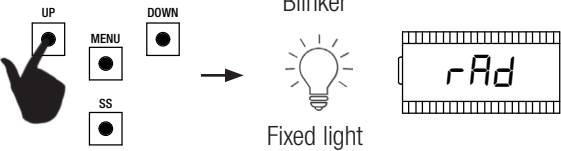
1. 1st memorized key: STEP-BY-STEP function.
2. 2nd memorized key: PARTIAL OPENING function.
3. 3rd memorized key: OPEN function.
4. 4th memorized key: CLOSE function.

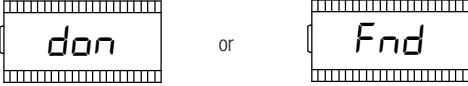

6.1 - LEARNING OF A TRANSMITTER

| | | |
|----|--|---|
| 1. | Make sure that the board is out from any programming menus. To quit, press briefly the "MENU" button until the display shows the state of the control unit. |  |
| 2. | Press and release the "UP" button. The display shows <i>rAd</i> and the blinker will be turned on with a fixed light. |  |
| 3. | Press the key of the remote control to be memorised within 10 seconds. |  |
| 4. | If the memorisation has been successful, the display shows <i>don</i> or <i>Fnd</i> (transmitter already memorized). |  |
| 5. | After 2 seconds the display will show the memory location of the memorized transmitter (for example <i>235</i>). |  |
| 6. | To memorise another key of the remote control (or a new transmitter), repeat the procedure from the point 2. | |

⚠ WARNING - after 10 seconds of inactivity, the control unit exits from the learning phase (the display shows *LoUt*).



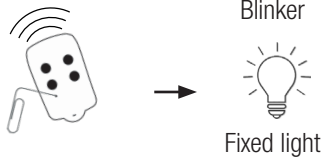

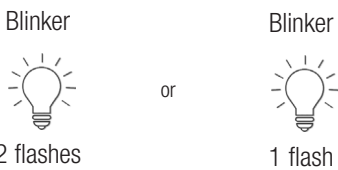
ENG

6.2 - LEARNING WITH THE HIDDEN KEY OF A TRANSMITTER ALREADY MEMORIZED

| | | |
|----|--|---|
| 1. | With the automation steady, with the aid of a clip press the hidden key of a transmitter already memorized, the flashing light lights on: now it is possible to memorize new keys or transmitters. |  |
| 2. | Press the key of the remote control to be memorised within 10 seconds. |  |
| 3. | If the memorisation has been successful, the blinker flashes 2 times (new transmitter) or 1 time (transmitter already memorized). |  |
| 4. | To memorise another key of the remote control (or a new transmitter), repeat the procedure from the point 1. | |

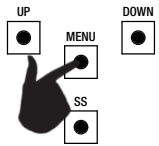
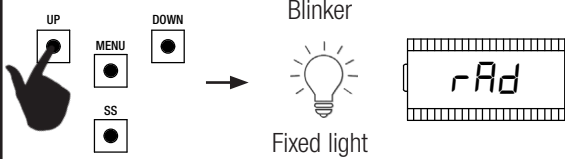
WARNING - after 10 seconds of inactivity, the control unit exits from the learning phase (the display shows $\epsilon o u t$).

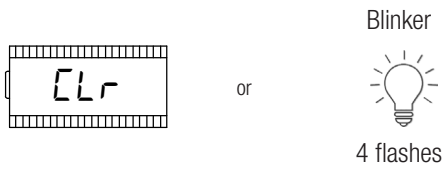
6.3 - CANCELLATION OF A SINGLE TRANSMITTER

| | | |
|----|---|---|
| 1. | Make sure that the board is out from any programming menus. To quit, press briefly the "MENU" button until the display shows the state of the control unit. |  |
| 2. | Press and release the "UP" button or the hidden key of a transmitter already memorized. The display shows rAd and the flashing light will be turned on fixed. |  |
| 3. | Press at the same time the hidden key and the 1st key of the transmitter that you want to delete within 10 seconds. |  |
| 4. | If the deleting has been successful, the display shows $\epsilon L r$ and the blinker flashes 4 times. |  |
| 5. | After 2 seconds the display will show the memory location of the deleted transmitter (for example 235). |  |

WARNING - after 10 seconds of inactivity, the control unit exits from the learning phase (the display shows $\epsilon o u t$).

7 - SETTING OF THE STROKE

NOTE - check with the advanced menu *dE.F.* (chapter 9) if the selected motor type is correct, before carrying out the learning.
At the first power up, it is necessary to carry out a learning of the stroke for the acquisition of the stroke length and the slowdowns.
After this procedure the installation is complete. To customize the automation, proceed as described in the chapter 8.
WARNING - Be sure that the limit switches are connected and correctly adjusted.

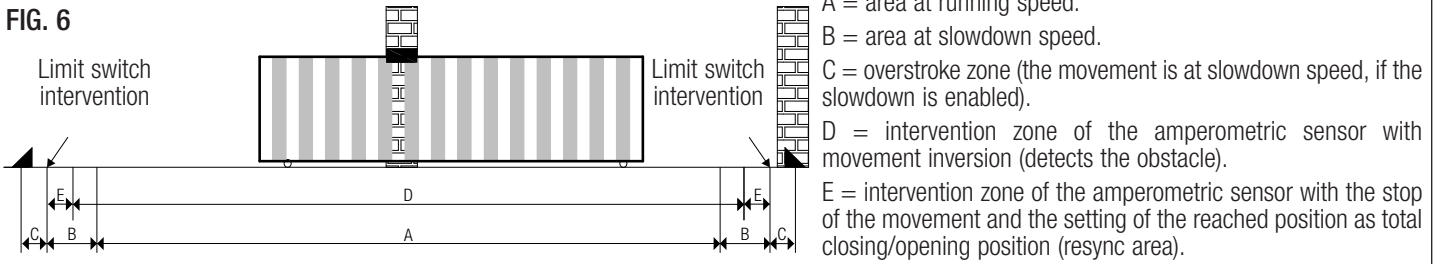





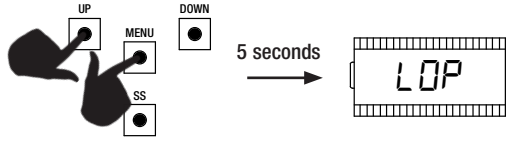

7.1 - EASY SETTINGS OF THE STROKE

| | | |
|----|---|--|
| 1. | <p>Be sure that the limit switches are connected and correctly adjusted. Carry out a check of the menus and, if needed, customize the settings before the learning of the stroke. The slowdowns will be those set in the menu, with the same percentage during both opening and closing ($L5i \neq P$).</p> | |
| 2. | <p>Unlock the automation and move it to the middle of the stroke Press at the same time the "UP" and "MENU" buttons for at least 5 seconds until the display shows LDP.</p> | |
| 3. | <p>If the automation DOESN'T MOVE in opening, press the "DOWN" button to stop the learning. The display shows L--.</p> | |
| 4. | <p>Press the "SS" button to restart the procedure: the automation moves in opening, at reduced speed, until it reaches the limit switch. In this phase the display shows LDP.</p> | |
| 5. | <p>Reached the opening limit switch, the automation moves automatically in closing, at running speed, until it reaches the closing limit switch. In this phase the display shows LCL.</p> | |
| 6. | <p>Reached the closing limit switch, the automation moves automatically in closing, at running speed, until it reaches the opening limit switch. In this phase the display shows LDP.</p> | |
| 7. | <p>Reached the opening limit switch, the automation moves in closing at running speed and with the slowdowns set into the menu $L5i$.</p> | |

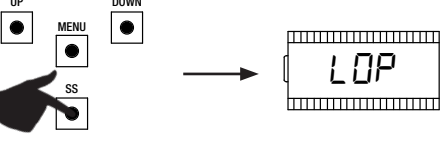
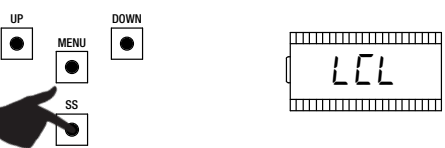
WARNING - in the event of a safety device intervention, the learning is stopped and will appear on the display **L--.
Press the "SS" button to start again the learning from the 4th point.**

7.2 - ADVANCED SETTINGS OF THE STROKE

| | | |
|----|---|---|
| 1. | <p>Be sure that the limit switches are connected and correctly adjusted. Carry out a check of the menus and, if needed, customize the settings before the learning of the stroke. Be sure to have set the item menu $L5I = P$. The slowdowns should be set during the learning procedure and the amplitudes will be independent in the two directions.</p> | |
| 2. | <p>Unlock the automation and move it to the middle of the stroke Press at the same time the "UP" and "MENU" buttons for at least 5 seconds until the display shows LOP.</p> |  |
| 3. | <p>If the automation <u>DOESN'T MOVE</u> in opening, press the "DOWN" button to stop the learning. The display shows $L--$.</p> |  |
| 4. | <p>Press the "SS" button to restart the procedure: the automation moves in opening, at reduced speed, until it reaches the limit switch. In this phase the display shows LDP.</p> |  |
| 5. | <p>Reached the opening limit switch, the automation moves automatically in closing, at running speed. When the automation reaches the position for the beginning of the slowdown, give a Step-by-Step command (SS). In this phase the display shows LCL.</p> |  |
| 6. | <p>The automation proceeds at slowdown speed until it reaches the closing limit switch. The automation moves automatically in opening, at running speed. In this phase the display shows LCL and then LOP.</p> |  |
| 7. | <p>When the automation reaches the position for the beginning of the slowdown, give a Step-by-Step command (SS). In this phase the display shows LDP.</p> |  |
| 8. | <p>The automation proceeds at slowdown speed until it reaches the opening limit switch. In this phase the display shows LDP.</p> |  |
| 9. | <p>Reached the opening limit switch, The automation moves in closing at running speed with slowdowns set.</p> |  |

WARNING - in the event of a safety device intervention, the learning is stopped and will appear on the display $L--$. Press the "SS" button to start again the learning from the 4th point.

ENG

8 - CHANGE PARAMETERS - BASIC MENU

It is possible to access a BASIC MENU to change the main parameters of the control unit.

To enter the menu, proceed as described below.

WARNING - after 2 minutes of inactivity, the control unit exits automatically from the menu.

Example of use and modify in the BASIC MENU

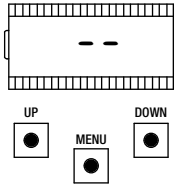

Make sure that the board is out from any programming menus (press briefly the "MENU" button).

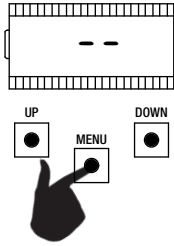

To enter the basic menu, press and hold the "MENU" button for at least 1 second.

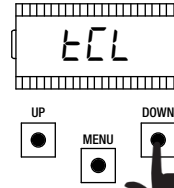

Use the "UP" and "DOWN" buttons to move inside the items of the menu.

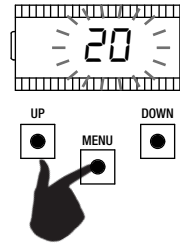

To enter the item, press and hold the "MENU" button for at least 1 second until the value blinks.

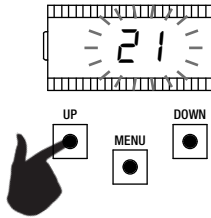

Use the "UP" and "DOWN" buttons to change the value.

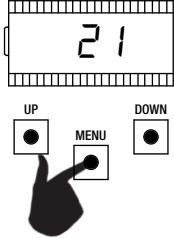

To save the value, press and hold the "MENU" button for at least 1 second.
To quit without saving, press briefly the "MENU" button.

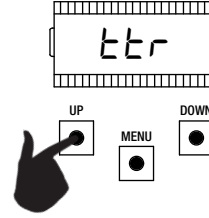

Use the "UP" and "DOWN" buttons to move inside the items of the menu.

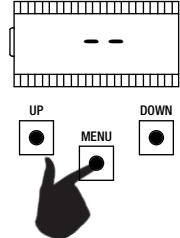

To quit, press briefly the "MENU" button.

| | PARAMETERS | DESCRIPTION | DEFAULT CUSTOM | MIN | MAX | UNIT |
|---|------------|--|-------------------|-----|-----|------|
| 1 | tCL | Auto reclosing time (0 = disabled). | 0 | 0 | 900 | s |
| 2 | ttr | Auto reclosing time after transit (0 = disabled). | 0 | 0 | 30 | s |
| 3 | SEn | Obstacle sensitivity with running speed (0 = disabled). | 40 | 0 | 100 | % |
| 4 | SEL | Obstacle sensitivity during slowdowns (0 = disabled). | 60 | 0 | 100 | % |
| 5 | SPn | Running speed. | 100 | 50 | 100 | % |
| 6 | SPL | Slowdowns speed | 50 | 10 | 100 | % |
| 7 | Sbs | SS configuration 0 = normal (OP-ST-CL-ST-OP-ST...) 1 = alternated STOP (OP-ST-CL-OP-ST-CL...) 2 = alternated (OP-CL-OP-CL...) 3 = condominium – timer 4 = condominium with immediate auto reclosing | 0 | 0 | 4 | |
| 8 | blt | After black-out 0 = no action 1 = closing | 0 | 0 | 1 | |

| | PARAMETERS | DESCRIPTION | DEFAULT CUSTOM | MIN | MAX | UNIT |
|----|------------|---|-------------------|-----|-----|------|
| 9 | <i>LSI</i> | Amplitude of slowdown. P = personalized during learning. 0...100% = percentage of stroke. | 20 | 0 | 100 | % |
| 10 | <i>ASL</i> | Anti slipping / Extra time. | 15 | 0 | 300 | s |

NOTE - the parameters highlighted in grey depend on the selected motor. In the table are reported the data of the CUSTOM motor. For more information, refer to chapter 11.

1. AUTO RECLOSING TIME t_{CL}

Active when the automation is in the completely open position, the automation automatically closes after t_{CL} seconds. In this phase the display shows $-t_{CL}$ with the blinking dash, that during the last 10 seconds will be replaced by the count down. An opening command or the photocells intervention restarts the counting.

2. AUTO RECLOSING TIME AFTER TRANSIT t_{E_r}

If in the opening phase or in the completely open position the beam of the photocells is obscured and freed, the automation automatically closes after t_{E_r} seconds when the completely open position is reached. In this phase the display shows $-t_{E_r}$ with the blinking dash, that during the last 10 seconds will be replaced by the count down.

3. OBSTACLE SENSITIVITY WITH RUNNING SPEED SE_n

Adjust the obstacle sensitivity to ensure a correct functioning of the automation, it must stop if there is an obstacle but also it must ensure the complete movement in the worst conditions (exp. winter, hardening of motors, etc). After the adjustment of this parameter it is recommended to perform a complete movimentation (opening and closing) before trying the obstacle detection.

Lower values correspond to a greater thrust on the obstacle.

The intervention for obstacle stops the automation and makes a short inversion of the movement.

4. OBSTACLE SENSITIVITY DURING SLOWDOWNS SE_L

Adjust the obstacle sensitivity during the slowdown to ensure a correct functioning of the automation, it must stop if there is an obstacle but also it must ensure the complete movement in the worst conditions (exp. winter, hardening of motors, etc). After the adjustment of this parameter it is recommended to perform a complete movimentation (opening and closing) before trying the obstacle detection.

Lower values correspond to a greater thrust on the obstacle.

The intervention for obstacle stops the automation and makes a short inversion of the movement.

5. RUNNING SPEED SP_n

Adjust the running speed to ensure a correct functioning of the automation. It is possible to adjust the percentage of speed between 50% and 100%.

WARNING - after the amendment of this parameter, it is necessary to carry out a new setting of the strokes.

6. SLOWDOWNS SPEED SP_L

Adjust the slowdowns speed to ensure a correct functioning of the automation. It is possible to adjust the percentage of speed between 10% and 100% of the running speed SP_n .

WARNING - after the amendment of this parameter, it is necessary to carry out a new setting of the strokes.

7. STEP BY STEP CONFIGURATION (SS) $Sb5$

It is possible to set 5 different working modes for the SS command:

- $Sb5 = 0$ normal (AP-ST-CH-ST-AP-ST-CH-...).
Typical functioning of Step by Step. During the movement a SS command stops the automation.
- $Sb5 = 1$ alternated STOP (AP-ST-CH-AP-ST-CH-...).
Alternated functioning with STOP during the opening. During the opening phase a SS command stops the automation.
- $Sb5 = 2$ alternated (AP-CH-AP-CH-...).
The user cannot stop the automation during the movement with a SS command.
A SS command during the movement inverts the movement.
- $Sb5 = 3$ condominium – timer.
A SS command only opens the automation. When the automation is completely open, if the command persists the control unit will wait until the opening of the contact before beginning the countdown of the automatic reclosing (if enabled), another SS command in this phase will restart the countdown of the automatic reclosing.
- $Sb5 = 4$ condominium with immediate auto reclosing.
Like condominium – timer (previous point) but during the countdown a SS command will close the automation.

8. AFTER BLACK-OUT b_{LE}

When the control unit switches on after a black-out, the behaviour of the control unit depends on the parameter b_{LE} :

- $b_{LE} = 0$ no action – when the control unit turns on the automation doesn't move until the first command. The first movement is an opening.
- $b_{LE} = 1$ closing – at the turning on of the control unit it will perform a closing.

9. AMPLITUDE OF SLOWDOWN LSI

With this parameter it is possible to adjust the amplitude of the slowdown and eventually disable it ($LSI = 0$). If you need more precise or different slowdown between opening and closing it is possible to set the parameter LSI on P (personalized) and perform an advanced learning of strokes providing also the beginning of slowdowns during the learning.

10. ANTI SLIPPING / EXTRA TIME ASL

This parameter is used if the motor slips, the control unit adds ASL seconds to the movement, to ensure a complete movement of the automation also in the worst conditions.

9 - CHANGE PARAMETERS - ADVANCED MENU

This menu allows a more detailed setting of some parameters.

To enter the ADVANCED MENU, press and hold the "MENU" button for at least 5 seconds.

To change the parameters, proceed as described for the BASIC MENU.

WARNING - after 2 minutes of inactivity, the control unit exits automatically from the menu.

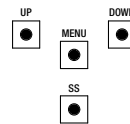

| | PARAMETERS | DESCRIPTION | DEFAULT CUSTOM | MIN | MAX | UNIT |
|----|------------------------------------|---|-------------------|-----|-----|---------|
| 1 | <i>S_{int}</i> | Intervention mode of the current sensor: 0 = disabled. 1 = complete (limit switch and obstacle) ¹ 2 = only obstacle detection in any point of the stroke. 3 = only end of the movement in any point of the stroke. ¹ | 2 | 0 | 3 | |
| 2 | <i>S_{it}</i> | Intervention time of the current sensor. | 2 | 1 | 10 | x 100ms |
| 3 | <i>S_{dt}</i> | The disabling time of the current sensor during the start of the motor. | 15 | 0 | 30 | x 100ms |
| 4 | <i>U_{rA}</i> | Acceleration ramp amplitude: 0...20 = ramp amplitude. <i>55_r</i> = single step at 50% of the running speed. ² <i>155_r</i> = single step at 100% of the running speed. ² | 10 | 0 | 20 | x 35ms |
| 5 | <i>d_{rA}</i> | Deceleration ramp amplitude. | 10 | 0 | 20 | x 35ms |
| 6 | <i>SP_h</i> | Functioning of closing photocell (PH1) moving from closed: 0 = check PH1. 1 = the automation opens also with PH1 obscured. | 1 | 0 | 1 | |
| 7 | <i>Ph₂</i> | Functioning of opening photocell PH2 0 = enabled in opening and closing. 1 = enabled only in opening. | 0 | 0 | 1 | |
| 8 | <i>t_{Ph}</i> | Photocells test: 0 = disabled. 1 = enabled PH1. 2 = enabled PH2. 3 = enabled PH1 and PH2. | 0 | 0 | 3 | |
| 9 | <i>E_{d_{int}}</i> | Safety edge type: 0 = contact (NC). 1 = resistive (8k2). | 0 | 0 | 1 | |
| 10 | <i>i_{E.d.}</i> | Operation mode of safety edge: 0 = working only in closing with inversion of movement. 1 = stops the automation (both opening and closing) and free the obstacle (short inversion). | 0 | 0 | 1 | |
| 11 | <i>t_{E.d.}</i> | Safety edge test: 0 = disabled. 1 = enabled. | 0 | 0 | 1 | |
| 12 | <i>LP_o</i> | Partial opening. | 30 | 0 | 100 | % |
| 13 | <i>t_{PC}</i> | Auto reclosing time from partial opening (0 = disabled). | 0 | 0 | 900 | s |
| 14 | <i>FP_r</i> | Blinker output mode: 0 = fix. 1 = blinking. | 1 | 0 | 1 | |
| 15 | <i>t_{Pr}</i> | Pre-flashing time (0 = disabled). | 0 | 0 | 10 | s |
| 16 | <i>FC_y</i> | Courtesy lighth settings: 0 = at the end of the movement for a <i>t_{CY}</i> time. 1 = on if the automation is not closed + <i>t_{CY}</i> time. 2 = on if the courtesy light timer (<i>t_{CY}</i>) is not expired. 3 = open automation light on/off. 4 = open automation light with proportional flashing. | 0 | 0 | 4 | |
| 17 | <i>t_{CY}</i> | Courtesy light time. | 180 | 0 | 900 | s |
| 18 | <i>d_{EA}</i> | Dead-man: 0 = disabled. 1 = enabled. | 0 | 0 | 1 | |

ENG

| | PARAMETERS | DESCRIPTION | DEFAULT CUSTOM | MIN | MAX | UNIT |
|----|---------------|--|-------------------|-----|-----|---------------|
| 19 | <i>SE.r.</i> | Threshold of cycles for assistance request. Once the limit is reached the next cycles will be done with fast blinking (only if <i>FP.r.</i> enabled). 0 = disabled. | 0 | 0 | 100 | x 1000 cycles |
| 20 | <i>SE.F.</i> | Continuous blinking for assistance request (done only with closed automation): 0 = disabled. 1 = enabled. | 0 | 0 | 1 | |
| 21 | <i>ri.ii.</i> | Mode of use of the R1 output (plug-in): 0 = output not used. 1 = courtesy light (copy of the control unit output). 2 = ECOMODE. | 1 | 0 | 1 | |
| 22 | <i>ip.r.</i> | Pressure of the motor in closed position. ² | 0 | 0 | 480 | min |
| 23 | <i>ir.E.</i> | Function for the mechanical relaxation of the motor. ² | 0 | 0 | 10 | x 50ms |
| 24 | <i>SF.t.</i> | Function for SOFT STOP | 5 | 0 | 10 | x 100ms |
| 25 | <i>dE.F.</i> | Restore default settings depending on the motor type: 0 = CUSTOM 1 = KALOS XL / MOVEO 2 = KALOS 70 3 = KALOS 110 4 = SIM 5 = KALOS XL FAST | 0 | 0 | 5 | |
| 26 | <i>tr.S.</i> | Viewing of the memory location for a single transmitter. | | | | |
| 27 | <i>tr.C.</i> | Cancellation of a single transmitter. | | | | |
| 28 | <i>tr.F.</i> | Cancelling all transmitters. Enter to modify the parameter and then keep pressed the "MENU" button, a count down appears that ends with <i>don</i> on the display. | | | | |
| 29 | <i>Si.d.</i> | First coupling between Bluetooth device and control unit. | | | | |

¹ **WARNING - do not use on the sliding motors.**

² These values are not suggested for the sliding motors.

NOTE - the parameters highlighted in grey depend on the selected motor. On the table are reported the data of the CUSTOM motor. For more information, refer to chapter 11.

1. MODE OF THE SENSOR INTERVENTION *Sn.ii.*

It is possible to select 4 intervention types for the current sensor that detect the motor blocked:

- *Sn.ii.* = 0 sensor is disabled.
- *Sn.ii.* = 1 complete functioning: intervention for obstacle detection in the central zone of the stroke and intervention for the ends of the movement in the areas near the limit switch. **Do not use with sliding gates.**
- *Sn.ii.* = 2 the sensor intervenes only for obstacle detection in any position.
- *Sn.ii.* = 3 the sensor intervenes only as end of the movement in any position. **Do not use with sliding gates.**

2. INTERVENTION TIME OF THE SENSOR *Si.t.*

Time after which intervenes the sensor for the motor blocked detection (current sensor) with an obstacle.

3. DISABLING TIME DURING THE START OF THE MOTOR *Sd.t.*

Time in which the current sensors is disabled during the start of the motor.

4. ACCELERATION RAMP *Ur.R.*

This parameter allows to set the acceleration ramp amplitude during the start of the motor. Higher is the value and longer will be the ramp. With *Ur.R.* = 0, the ramps are disabled and the motor starts directly at the running speed or at the slowdown speed, depending on the position during the stroke.

In addition to the numerical values, there are 2 additional options:

- *5S.r.* - the motor starts at the 50% of the running speed for 0,6 seconds.
- *H5.r.* - the motor starts at the 100% of the running speed for 0,6 seconds.

5. DECELERATION RAMP *dr.R.*

This parameter allows to set the deceleration ramp amplitude from the running speed to the slowdown speed. Higher is the value and longer will be the ramp.

6. FUNCTIONING OF PH1 FROM CLOSED POSITION *SP.h.*

The closing photocell has the following functioning:

- Closing: immediate inversion of the movement.
- Opening from an intermediate position: no intervention.
- Opening from closed position:
 - *SP.h.* = 0 the automation doesn't move if PH1 beam is cut.
 - *SP.h.* = 1 the automation moves while PH1 beam is cut.

7. FUNCTIONING OF PH2 $Ph.2$.

The opening photocell has the following functioning:

- **Opening:** stops the movement and waits until the beam is freed, then moves in opening.
- **Closing:**
 - $Ph.2 = 0$ stops the movement and waits until the beam is freed, then moves in opening.
 - $Ph.2 = 1$ no intervention.

8. PHOTOCELLS TEST $EP.h$.

By enabling this function, before each movement starting from steady automation, the control unit does a functional check of the photocells. The check will not be done in case of fast movement after the intervention of a safety device. Follow paragraph 4.1 for the connections of the photocells.

9. SAFETY EDGE TYPE $Ed.i$.

The control unit can work with two different types of safety edges:

- $Ed.i = 0$ mechanical with normally closed contact.
- $Ed.i = 1$ resistive edge $8,2K\Omega$.

10. OPERATION MODE OF SAFETY EDGE $iE.d$.

To allow the installation of the safety edges in both the directions of movements, it is possible to choose 2 different functionings:

- $iE.d = 0$ only in closing with total inversion of the movement.
- $iE.d = 1$ both directions of movements, stop and short inversion to free the obstacle.

11. SAFETY EDGE TEST $tE.d$.

By enabling this function the control unit does a functional check of the safety edge. This function is used if the edge connected to the control unit has an electronic self test (exp. radio edge R.CO.O). Connect the test contact of the edge to the power supply of the transmitter of the photocells (paragraph 4.1) and enable the self test with low voltage 0Vdc (for the compatibility follow the instruction of the safety edge with the electronic self test).

12. PARTIAL OPENING $LP.o$.

Partial opening can be performed only starting from a closed position. The parameter sets the opening like a percentage of the total stroke.

13. AUTO RECLOSING TIME FROM PARTIAL OPENING $tP.C$.

Active when the automation is in the partial opening, it automatically closes after $tP.C$ seconds. In this phase the display shows $-tC$ with the blinking dash, that during the last 10 seconds will be replaced by the count down.

14. FLASHING LIGHT OUTPUT MODE $FP.r$.

It is possible to choose 2 different functionings for the blinker output:

- $FP.r = 0$ fixed output. It will be necessary to connect a self flashing blinker (B.RO LIGHT 24 Vac).
- $FP.r = 1$ flashing light output. It will be necessary to connect a fix light blinker (B.RO LIGHT FIX 24 Vac).

15. PRE-FLASHING TIME $tP.r$.

Pre-flashing before each movement in both directions, $tP.r$ seconds of pre-flashing.

16. COURTESY LIGHT SETTINGS $FC.y$.

The control unit has 4 different functionings for the courtesy light:

- $FC.y = 0$ the light switches off at the end of a movement after $tC.y$ seconds.
- $FC.y = 1$ the light switches off only with closed automation after $tC.y$ seconds $tC.y$.
- $FC.y = 2$ lighted on for $tC.y$ seconds from the beginning of a movement, independently on the conditions of the automation (the light could switch off before the end of the movement).
- $FC.y = 3$ open automation light - the light switches off immediately when the automation reaches the closed position.
- $FC.y = 4$ open automation light with proportional blinking:
 - **Opening:** slow blinking.
 - **Closing:** fast blinking
 - **Opened:** light on
 - **Closed:** light off.
 - **Stopped:** 2flash + long wait + 2flash + long wait + ...

17. COURTESY LIGHT TIME $tC.y$.

Activation time of the courtesy light.

18. DEAD MAN $dE.R$.

During the DEAD MAN functioning mode the automation moves only with a permanent command.

The enabled commands are OPEN and CLOSE. SS and PED are disabled. During the dead man functioning all the automatic movements are disabled, like short or total inversions. All safety devices are disabled except for STOP.

19. SETTING THE CYCLES THRESHOLD FOR ASSISTANCE REQUEST $SE.r$.

It is possible to set a number of cycles before the request of assistance. Once the limit is reached, the next cycles will be done with a fast blinking (only if $FP.r = 1$).

20. CONTINUOUS FLASHING LIGHT FOR ASSISTANCE REQUEST $SE.F$.

Once the limit $SE.F$ is reached the flashing light will blink also with the automation closed to show the request of assistance.

21. MODE OF USE OF THE R1 OUTPUT $r1.i$.

This parameter allows to select the functioning of the R1 card (optional):

- $r1.i = 0$ The output is disabled.
- $r1.i = 1$ Courtesy light: the NO contact (without voltage) of the R1 card has the same functioning of the output OGL.
- $r1.i = 2$ Ecomode: it enables the ECOMODE function and the NO contact of the R1 card is used to cut the power supply of the 24Vdc accessories. See chapter 10.

22. PRESSURE OF THE MOTOR IN CLOSED POSITION $iP.r$.

This function is used to keep the pressure of the motors on the mechanical stop, performed only with closed automation. The control unit performs 1

minute of closing every $\bar{P}.r$ minutes to keep the pressure on the mechanical stops.

WARNING - Do not use with sliding gates.

23. MECHANICAL RELAXATION $\bar{r}.E$.

Function for the mechanical relaxation of the motor: it is useful on those motors that have the unlock for the manual movement which can remain locked due to the pressure of the motor on the mechanical stop. When it arrives on the mechanical stop, opening or closing, the motor will do a short inversion of $\bar{r}.E$. x 50ms.

NOTE - with $\bar{P}.r$ with function enabled (pressure of the motor in closed position), the mechanical relaxation is performed only on the first positioning on the mechanical stop.

WARNING - Do not use with sliding gates.

24. FUNCTION SOFT STOP $5Ft$

With the $5Ft$ parameter, it is possible to stop the gate in a soft way. This behaviour takes place on all step-by-step and stop commands. $5Ft$ determines a soft stop even in the case of safety intervention, except for the intervention of the safety edge (EDGE) or for the intervention of the photocell PH1.

25. RESTORE DEFAULT SETTINGS $dE.F$.

With the item of the menu $dE.F$. it is possible to restore the default settings of the control unit. The reset will restore all the parameters of the base and advanced menu, but doesn't modify the learnt strokes.

Move to $dE.F$. then press and hold the "MENU" button until the display shows a number (for example 0), then release the button.

Select the used motor with the "UP" and "DOWN" buttons:

- 0: CUSTOM
- 1: KALOS XL / MOVEO
- 2: KALOS 70
- 3: KALOS 110
- 4: SIM
- 5: KALOS XL FAST

Press and hold the "MENU" button until the number stops blinking, then release the button. Press and hold the "MENU" button, the display will show a count down $d80, d79, \dots, d0$ I don't release the button until the display shows $d0n$.

NOTE - to know the type of the selected motor, move on the item menu $dE.F$.: the display shows alternating the $dE.F$. and the selected motor. If a parameter changes (that depends on the motor type, see chapter 11), on the display will also appear the letter c (for example $c 1$).

26. VIEWING OF THE MEMORY POSITION FOR A SINGLE TRANSMITTER $t.r.5$.

With the item of the menu $t.r.5$. it is possible to view the memory location in which a transmitter is memorized.

To perform the function, move to $t.r.5$. and then confirm by pressing the "MENU" button. Keep pressed the "MENU" button until the display will show $5EE$, then release the button.

At this point press a button of the memorized transmitter (it does not active any command). The display shows:

- the memory location for 2 seconds, if is memorized;
- the written $n0t$ for 2 seconds, if is not memorized.

After 2 seconds the display returns to the screen $5EE$ and it will be possible to perform this function with another transmitter.

To exit the function, press the "MENU" button. Otherwise, after 15 seconds without transmission, the control unit exits the function and shows the written $t0Ut$.

27. CANCELLATION OF A SINGLE TRANSMITTER $t.r.c$.

With the item of the menu $t.r.c$. it is possible to delete a single transmitter from the memory.

To perform the function, move to $t.r.c$. and then confirm by pressing the "MENU" button. Keep pressed the "MENU" button until the display will show 0, then release the button. Select the memory location of the transmitter. Press and hold the "MENU" button until the display will show cLr , then release the button.

To exit the function, press the "MENU" button. If the display shows the written $E-r-r$ there are problems with the memory (for example empty position or disconnected memory).

28. CANCELLING ALL THE TRANSMITTERS $t.r.F$.

With the item of the menu $t.r.F$. it is possible to erase all the transmitters learnt.

Move to $t.r.F$., then keep pressed the "MENU" button until the display shows 0, then release the button. Press again and keep pressed the "MENU" button, the display will show a count down $d80, d79, \dots, d0$ I do not release the button until the display shows $d0n$.

29. BLUETOOTH $5i .d$.

Item of the menu needed for the first coupling between an Android device and the control unit. Refer to the Help of the Android application for the connection procedure.

10 - ECOMODE

The ECOMODE function allows to increase the batteries life in the event of a black-out of the grid.
To enable the function:

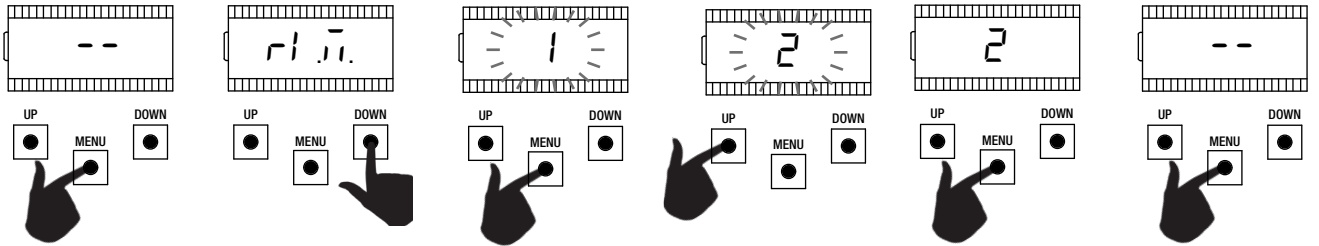

Make sure that the board is out from any programming menus (press briefly the "MENU" button). To enter the menu, press and hold the "MENU" button for at least 5 seconds.

Use the "UP" and "DOWN" buttons to move inside the items of the menu. Select the item *r1..*.

To enter the item, press and hold the "MENU" button for at least 1 second until the value blinks.

Use the "UP" and "DOWN" buttons to change the value.

To save the value, press and hold the "MENU" button for at least 1 second.

To quit, press briefly the "MENU" button.

For the correct functioning, connect the contact of the R1 card in series to the 24Vdc accessories, as showed in the diagram below. During the functioning with batteries, the control unit activates the motor at reduced speed (50% of the nominal speed) and all the accessories are switched OFF.

WARNING - in this situation the safety devices ARE NOT ACTIVATED. For a greater safety, we suggest to move the automation on sight. If during the functioning with batteries, the power supply comes back, after 5 seconds (activation time of the accessories), the motor will be restored to the running speed and the safety devices will be again monitored.

| Sliding gate | | 2 batteries 12V 0,8Ah | |
|--|-----------------------|-----------------------|----|
| Without grid power supply for: | | 2h | 8h |
| Conditions: • Weight: 330Kg. • Stroke: 2,2m. • Kalos XL motor. • Temperature: 15°C. • Battery charging time > 120h. | n° consecutive cycles | 10 | 5 |

Note: In the event it is necessary a more lasting operation without the grid power supply, batteries with a higher capacity are available.

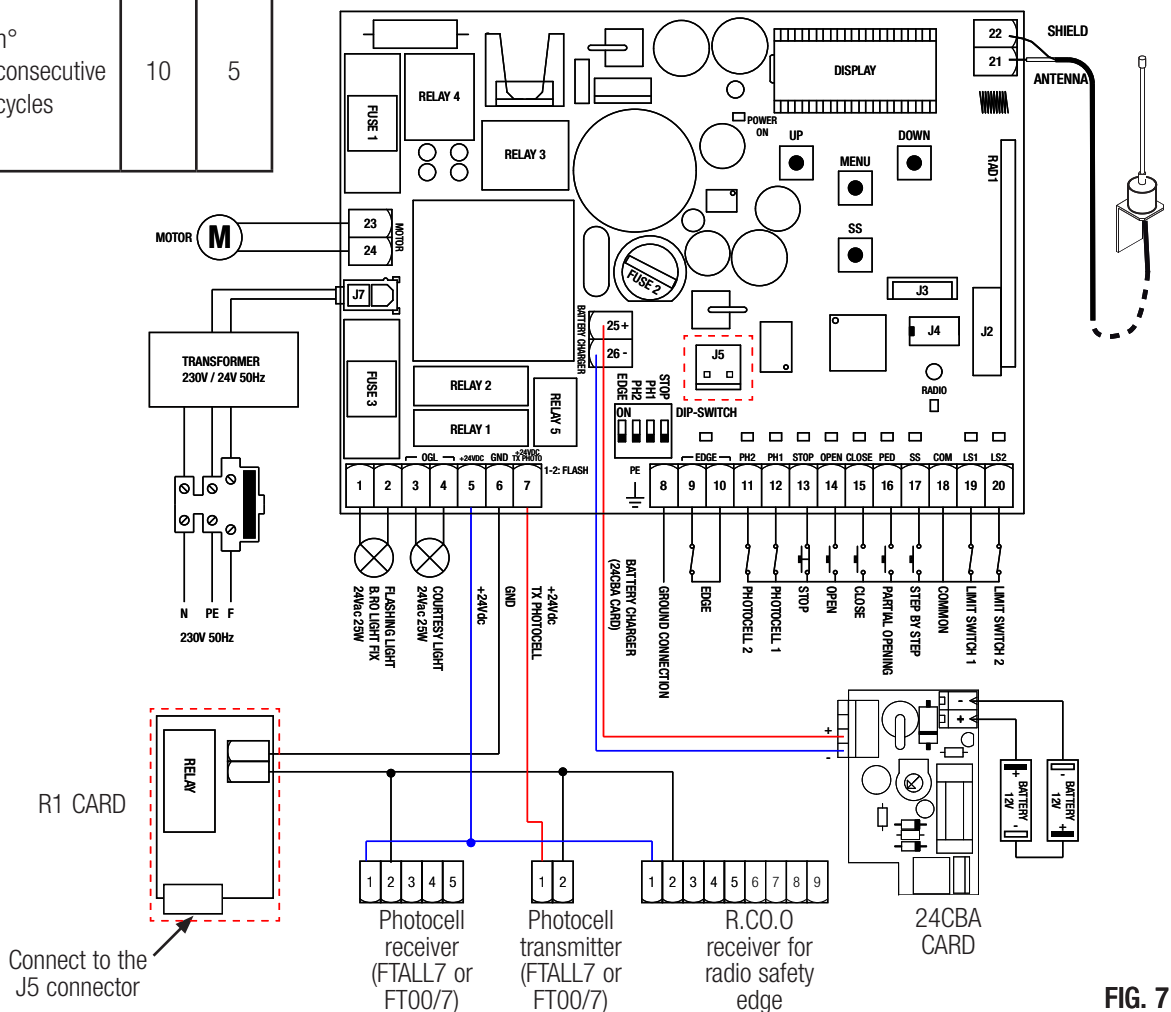

FIG. 7

ENG

11 - DEFAULT VALUES

The BIOS1 24V control unit has the possibility to select the used motor. This allows to set, as defaults, some parameters for the optimal functioning of the motor.

Here below, the table of the parameters with the default values assigned that depend on the motor.

| MENU | DISPLAY | SHORT DESCRIPTION | DEFAULT VALUES | | | | | |
|----------|------------|---|----------------|------------------|----------|-----------|-----|---------------|
| | | | CUSTOM | KALOS XL / MOVEO | KALOS 70 | KALOS 110 | SIM | KALOS XL FAST |
| BASE | <i>SEn</i> | Obstacle sensitivity with running speed | 40 | 40 | 40 | 40 | 40 | 10 |
| BASE | <i>SEL</i> | Obstacle sensitivity during slowdowns | 60 | 60 | 60 | 60 | 60 | 10 |
| BASIC | <i>SPn</i> | Running speed. | 100 | 100 | 100 | 100 | 100 | 100 |
| BASIC | <i>SPL</i> | Slowdowns speed. | 50 | 50 | 50 | 50 | 50 | 65 |
| BASIC | <i>ASL</i> | Anti slipping / Extra time. | 15 | 300 | 300 | 300 | 300 | 300 |
| ADVANCED | <i>Stt</i> | Intervention time of the current sensor. | 2 | 2 | 2 | 2 | 2 | 10 |
| ADVANCED | <i>Sdt</i> | Disabling time of the current sensor during the start of the motor. | 15 | 15 | 15 | 15 | 15 | 30 |
| ADVANCED | <i>UrA</i> | Acceleration ramp amplitude. | 10 | 10 | 10 | 10 | 10 | 10 |
| ADVANCED | <i>drA</i> | Deceleration ramp amplitude. | 10 | 10 | 10 | 10 | 10 | 10 |
| ADVANCED | <i>dEF</i> | Restore default settings. | 0 | 1 | 2 | 3 | 4 | 5 |

NOTE - To know the type of the selected motor, move on the item menu *dE.F.*: the display shows in alternance the selected motor number. If a parameter changes (that depends on the motor type), on the display will also appear the letter *c* (for example *c i*).

12 - WARRANTY

In compliance with legislation, the manufacturer's warranty is valid from the date stamped on the product and is restricted to the repair or free replacement of the parts accepted by the manufacturer as being defective due to poor quality materials or manufacturing defects. The warranty does not cover damage or defects caused by external agents, faulty maintenance, overloading, natural wear and tear, choice of incorrect product, assembly errors, or any other cause not imputable to the manufacturer. Products that have been misused will not be guaranteed or repaired. Printed specifications are only indicative. The manufacturer does not accept any responsibility for range reductions or malfunctions caused by environmental interference. The manufacturer's responsibility for damage caused to persons resulting from accidents of any nature caused by our defective products, are only those responsibilities that come under law.

13 - DISPOSAL OF THE PRODUCT

This product is an integral part of the automation, and therefore, they must be disposed of together. As for the installation operations, at the end of the life of this product, the dismantling operations must be performed by qualified personnel. This product is made from different types of materials: some can be recycled, others must be disposed of. Please inform yourselves on the recycling or disposal systems provided for by the laws in force in your area, for this category of product.



CAUTION! – some parts of the product can contain polluting or dangerous substances which, if dispersed in the environment, may cause serious harm to the environment and human health.

As indicated by the symbol at the side, it is forbidden to throw this product into domestic refuse. Therefore, follow the “separated collection” instructions for disposal, according to the methods provided for by local regulations in force, or redeliver the product to the retailer at the moment of purchase of a new, equivalent product.

CAUTION! – the regulations in force at local level may envisage heavy sanctions in case of abusive disposal of this product.

ALLMATIC S.r.l

32026 Borgo Valbelluna - Belluno – Italy

Via dell'Artigiano, n°1 – Z.A.

Tel. 0437 751175 – 751163 r.a.

<http://www.allmatic.com> - E-posta: info@allmatic.com