

CONTROL UNIT BIOS1

Programmable Control board for sliding gates

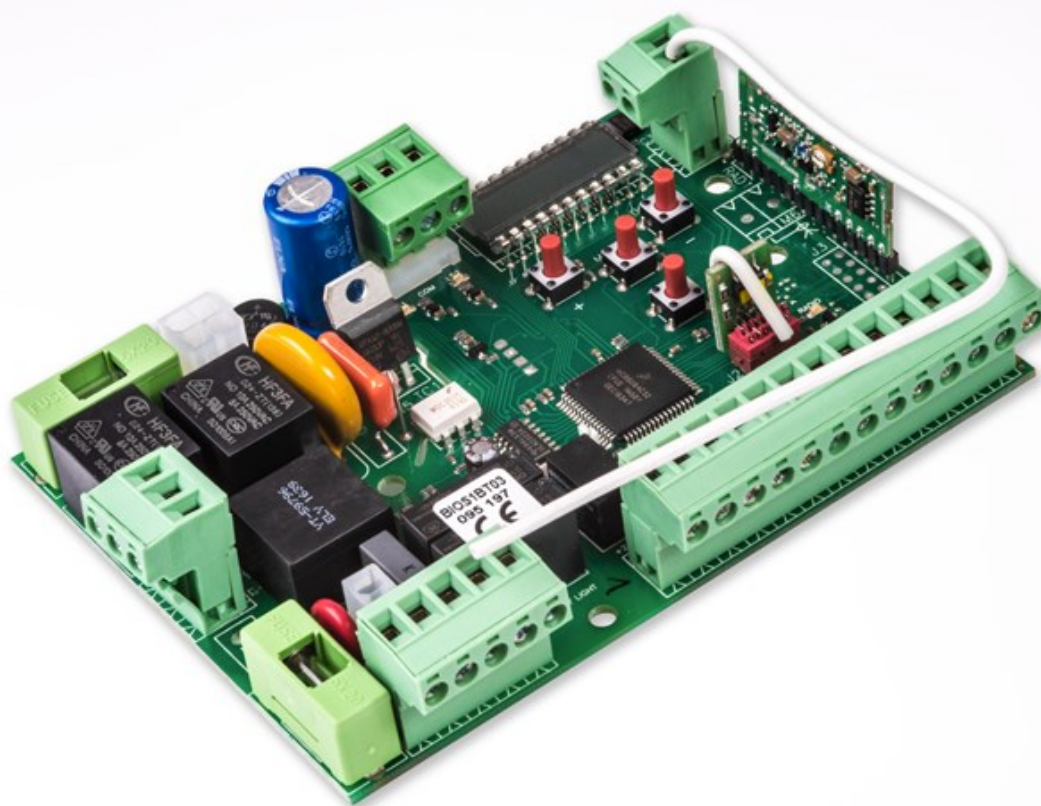

Manual for installation



1. Introduction

The control unit BIOS1 is particularly indicated for the installation of 1 230 Vac motor with maximum power absorbed of 700W. The control unit equipped with a display that allows a precise regulation of the thrust and sensitivity. The control unit can memorize up to 8000 transmitters with the external memory, with the step by step, partial opening, open and close functions. It is supplied with inputs for interior and exterior photocell, possibility to connect the buttons for step by step, partial opening, open, close and stop. The outputs include a 230 Vac flashing light, courtesy light/zone light/open gate light, 24 Vdc accessories power supply.



**ATTENTION: DO NOT INSTALL THE CONTROL UNIT WITHOUT READING THE INSTRUCTIONS FIRST !!!
THE INSTALLATION SHOULD BE PERFORMED ONLY BY QUALIFIED PERSONNEL.**

Be sure that the limit switches are connected and correctly adjusted

2. Configuration

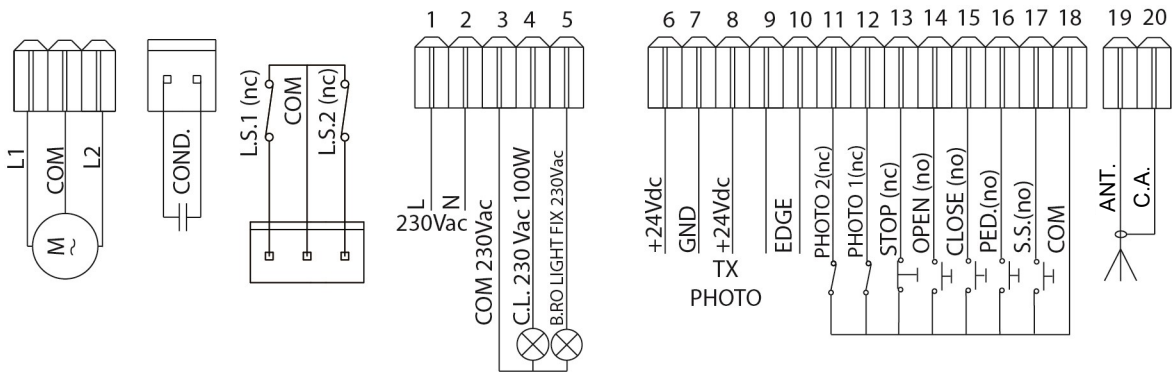
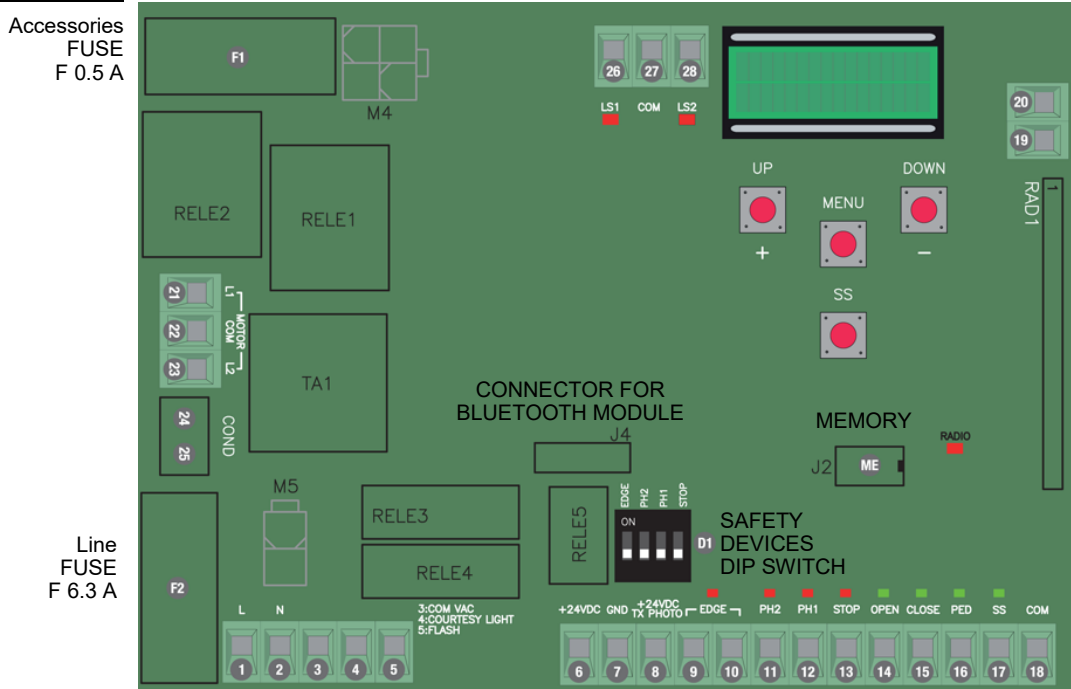

3. Connections

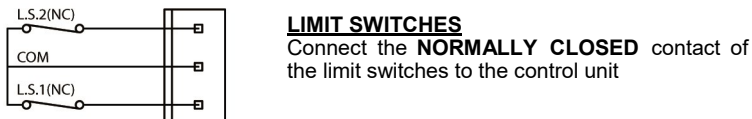
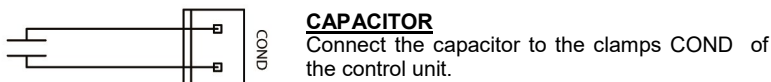
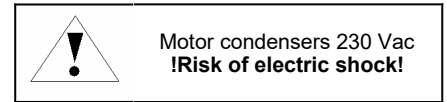
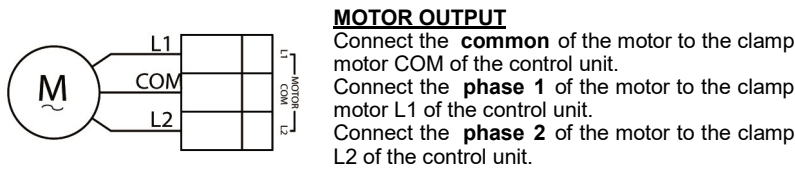

During the learning of the stroke phase the control unit recognize itself the opening and closing limit switch.

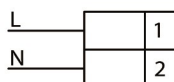

POWER SUPPLY

Connect the power supply cable between clamp 1 and 2 of the control unit

Power supply 230 Vac 50 Hz
Do not connect the card directly to the electric network. Put a device which can ensure the disconnection of each pole from the power supply of the control unit.

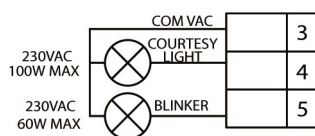

COURTESY LIGHT OUTPUT

Connect the courtesy light to the clamps 3 and 4, 230Vac 100W MAX.

It is possible to light up the action area of the automatism during each motion.
The functioning of the auxiliary light is controlled in the advanced menu *FcY*.

FLASHING LIGHT OUTPUT

Connect the flashing light to the clamps 3 and 5.

Use a flashing light without self flashing card 230Vac 60W MAX

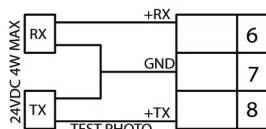

PHOTOCELLS POWER SUPPLY

Connect the **clamp 6** of the control unit to the **clamp +** of the power supply of the photocells receiver.

The photocells test is activated in the advanced menu *tPh*.

Connect the **clamp 7** of the control unit to the power supply **clamp -** of the photocells receiver and of the transmitter.

ATTENTION: the control unit gives a voltage of 24 Vdc and can supply a maximum power of 4W.

Connect the **clamp 8** of the control unit to the power supply **clamp** of the trasmitter of the photocells.

For the safety edge test connect the test device of the safety edge on the power supply pins of the TX (test activated wiht low logic signal 0Vdc). Please refer to the manual of the safety edge.

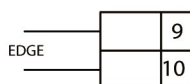

SAFETY EDGE INPUT

Connect the safety edge contacts to the clamps 9 and 10 of the control unit.

Select the type of security edge used (mechanical or 8K2) through the menu *Ed1*, select the type of functioning through the menu *iEd*.
If not used set the DIP switch EDGE ON.

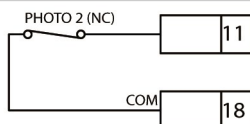

OPENING PHOTOCELL INPUT

Connect the **NORMALLY CLOSED** contact of the photocell (PHOTO 2) between the clamps 11 and 18 of the control unit.

The functioning of the opening photocell is controlled in the advanced menu *Ph2*.
If not used set the DIP switch PH2 ON.

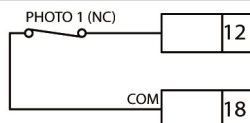

CLOSING PHOTOCELL INPUT

Connect the **NORMALLY CLOSED** contact of the photocell (PHOTO 1) between the clamps 12 and 18 of the control unit.

The functioning of the closing photocell is controlled in the advanced menu *5Ph*.
If not used set the DIP switch PH1 ON.

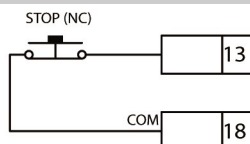

STOP INPUT

Connect the **NORMALLY CLOSED** contact of the STOP between the clamps 13 and 18 of the control unit.

If not used set the DIP switch STOP ON.

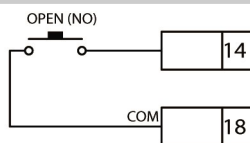

OPEN INPUT

Connect the button OPEN between the clamps 14 and 18 of the control unit.

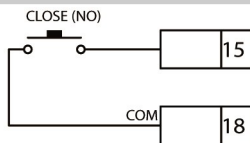

CLOSE INPUT

Connect the button CLOSE between the clamps 15 and 18 of the control unit.

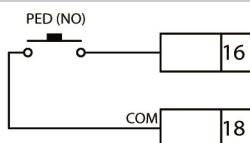

PARTIAL OPENING INPUT

Connect the button PED between the clamps 16 and 18 of the control unit.

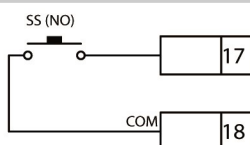

STEP BY STEP INPUT

Connect the button SS between the clamps 17 and 18 of the control unit.

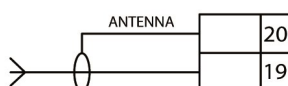

ANTENNA

Connect the signal cable of the antenna to the clamp 19 and the ground of the antenna to the clamp 20 of the control unit.

The presence of the metallic parts or humidity in the walls could have negative influences on the range of the system. We suggest therefore to not place the receiving antenna and/or transmitters near big metallic objects, near the floor or on the ground.

4. Remote control learning

4.1 Learning of one transmitter

The 1st memorized button performs the STEP by STEP function (opening and closing of the gate), the 2nd button performs the partial opening, the 3rd button performs the OPEN function, 4th button performs the CLOSE function.
The control unit exits from the learning phase if no new button or transmitter command is given in 10 seconds.

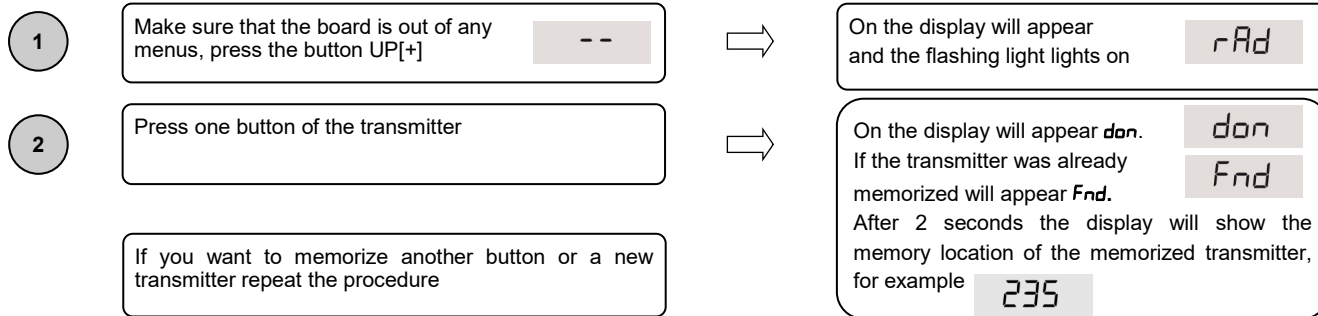

4.2 Learning with the hidden button of an already memorized transmitter

With the hidden button of a transmitter it is possible to enter the learning phase in order to memorize new buttons or new transmitters. With the automation still, with the aid of a clip press the hidden button of an already memorized transmitter, the flashing light lights on, now it is possible to memorize new buttons or transmitters.

4.3 Cancellation of one transmitter

Enter the learning phase with the UP[+] button or with the hidden button of a memorized transmitter (see 4.1 or 4.2). Press in the same time the hidden button and 1st button of the transmitter that you want to cancel. The flashing light blinks 4 times and on the display will appear CLR

5. Setting stroke

5.1 Easy settings of the stroke (parameter L5I ≠ P)

Be sure that the limit switches are connected and correctly adjusted

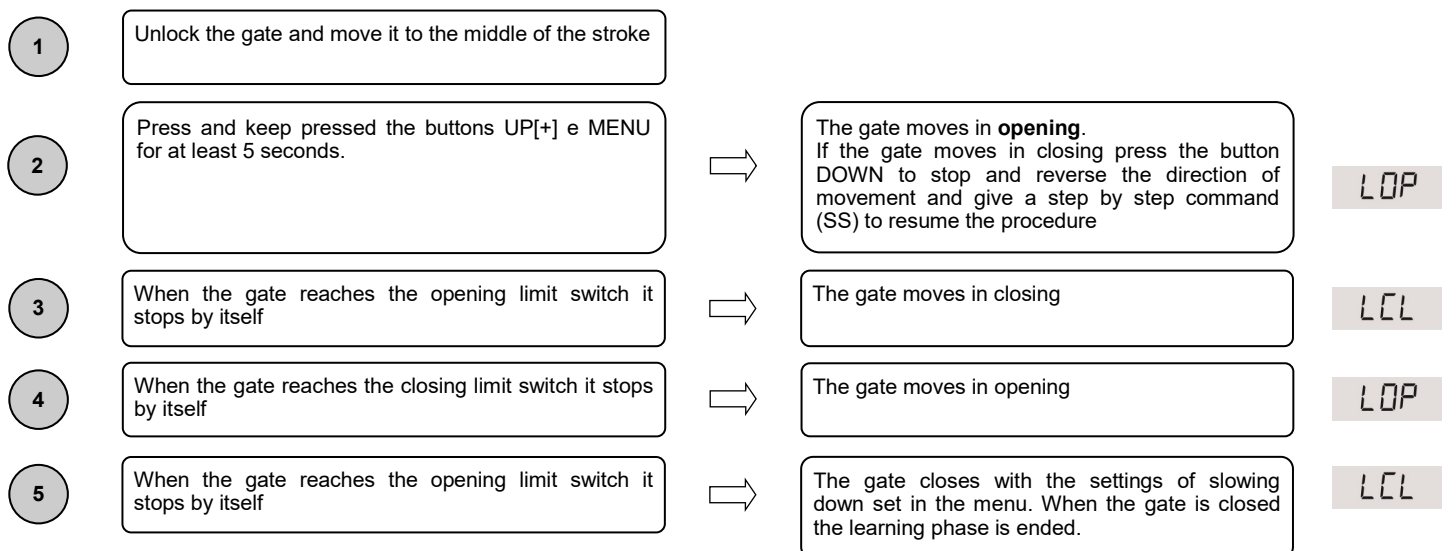

Warning: in case of intervention of a safety device, the learning is stopped and will appear on the display the written L--
Press Step by Step button to start again the learning from the 2nd point.

5.2 Advanced settings of the stroke (parameter $LSI = P$)

Be sure that the limit switches are connected and correctly adjusted

In this procedure is necessary to provide the positions of beginning of slowing down with a step by step command (SS).

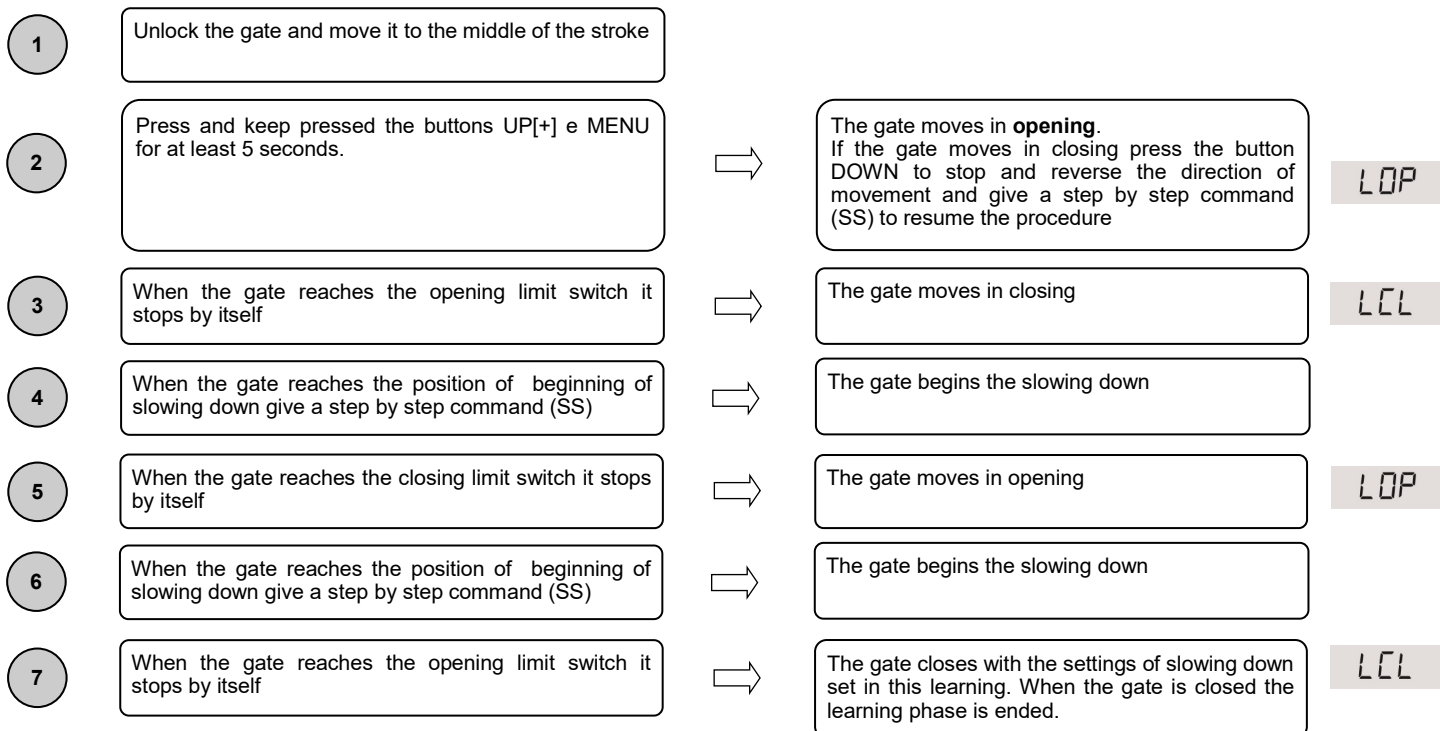

Warning: in case of intervention of a safety device, the learning is stopped and will appear on the display the written Press Step by Step button to start again the learning from the 2nd point.

L--

6. Menu

Entering the menu:

To enter the base menu settings keep pressed the MENU button for at least one second

To enter the advanced menu settings keep pressed the MENU button for at least five seconds

Navigation into the menu:

It is possible to move from an entry to another one using UP[+] e DOWN[-] buttons,

To change a parameter keep pressed the MENU button for at least 1 second until the parameter begins blinking, so release the button.

Use UP[+] and DOWN[-] buttons to change the parameter

At the end keep pressed MENU for at least 1 second until the parameter stops blinking to save the change.

A quick pressure of the menu button is enough to leave a menu

Ex. Base menu

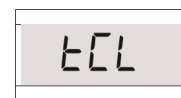

Ex. Advanced menu

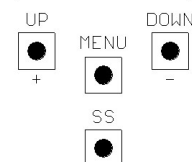

6.1 Base settings menu:

| MENU | DESCRIPTION | SELECTABLE VALUES min-max | DEFAULT | UNITS |
|-------|--|------------------------------|---------|-------|
| tCL | Auto reclosing time (0 = disabled) | 0-900 | 0 | s |
| ttr | Auto reclosing time after transit(0 = disabled) | 0-30 | 0 | s |
| SEI | Obstacle sensitivity (0 = disabled 100 = maximum sensitivity) | 0-100 | 0 | % |
| tr9 | Motor torque (running torque) | 10-100 | 100 | % |
| SSL | Slowing down mode 0 = normal 1 = fast with more torque | 0-1 | 0 | |
| Sbs | Step by step configuration 0 = normal (OP-ST-CL-ST-OP-ST...) 1 = alternated STOP (OP-ST-CL-OP-ST-CL...) 2 = alternated (OP-CL-OP-CL...) 3 = condominium – timer 4 = condominium with immediate auto reclosing | 0-4 | 0 | |
| blt | After black-out 0 = no action 1 = closing | 0-1 | 0 | |
| * SSt | Soft start 0 = disabled 1 = enabled | 0-1 | 0 | |
| * LSI | Amplitude of slowing down P = personalized during learning 0...100% = percentage of stroke | 0-100 | 15 | % |
| SLr | Deceleration ramp amplitude 0 = disabled 1:9 = ramp duration | 0-9 | 5 | |



*ATTENTION!

It is not advisable the disabling of the slowing downs and, if possible, use the "soft start" function.

6.2 Advanced menu:

| MENU | DESCRIPTION | SELECTABLE VALUES min-max | DEFAULT | UNITS |
|------------------------|--|------------------------------|---------|-------------|
| <i>Sl d</i> | First coupling between Bluetooth device and control unit | | | |
| <i>ELF.</i> | Electrical brake activation time 0 = disabled 1 - 100= enabled | 0-100 | 0 | x0.01 s |
| <i>SPh</i> | Functioning of PHOTO1 moving from closed 0 = Check PHOTO1 1 = The gate opens also with PHOTO1 busy | 0-1 | 1 | |
| <i>Ph2.</i> | Functioning of PHOTO2 0 = Enabled in opening and closing OP/CL 1 = Enabled only in opening OP | 0-1 | 0 | |
| <i>tPh</i> | Photocells test 0 = disabled 1 = enabled PHOTO1 2 = enabled PHOTO2 3 = enabled PHOTO1 and PHOTO2 | 0-3 | 0 | |
| <i>Edi.</i> | Safety edge type 0 = contact (NC) 1 = resistive (8k2) | 0-1 | 0 | |
| <i>iEd</i> | Operation mode of safety edge 0= working only in closing with inversion of movement 1 = stops the automation (both opening and closing) and free the obstacle (short inversion) | 0-1 | 0 | |
| <i>tEd</i> | Safety edge test 0 = disabled 1 = enabled | 0-1 | 0 | |
| <i>LPo</i> | Partial opening | 0-100 | 30 | % |
| <i>tPCL</i> | Auto reclosing time from partial opening (0 = disabled) | 0-900 | 20 | s |
| <i>FP_r</i> | Blinker output mode 0 = Fix 1 = Blinking | 0-1 | 1 | |
| <i>tP_r</i> | Pre-flashing time (0 = disabled) | 0-10 | 0 | s |
| <i>FCY.</i> | Courtesy lighth settings 0 = At the end of movement for a TCY time 1 = On if the gate is not closed + TCY time 2 = On if courtesy light timer (TCY) not expired 3 = Open gate light on/off 4 = Open gate light with proportional flashing | 0-4 | 0 | |
| <i>tCY.</i> | Courtesy light time | 0-900 | 0 | s |
| <i>dEA</i> | Dead-man 0 = disabled 1 = enabled | 0-1 | 0 | |
| <i>SE_r</i> | Setting threshold of cycles for assistance request. Once limit is reached the next cycles will be done with fast blinking (only if <i>FP_r</i> enabled) (0 = disabled) | 0-100 | 0 | x1000 cicli |
| <i>SE_F</i> | Continuous blinking for assistance request (done only with closed gate). 0 = disabled 1 = enabled | 0-1 | 0 | |
| <i>t_rS.</i> | Viewing of the memory location for a single transmitter | 0-999 | | |
| <i>t_rL.</i> | Cancellation of a single transmitter | 0-999 | | |
| <i>dEF.</i> | Restore default settings, enter to modify the parameter and then keep pressed the MENU button, a count down appears that ends with <i>d_on</i> on the display | | | |
| <i>t_rF.</i> | Cancelling all transmitters, enter to modify the parameter and then keep pressed the MENU button, a count down appears that ends with <i>d_on</i> on the display | | | |

6.3 Menu description:

6.3.1 Base settings menu

ℓℓℓ Auto reclosing time

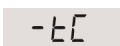
Active when the gate is in the completely open position, the gate automatically closes after ℓℓℓ seconds. In this phase the display shows  with the blinking dash, that during the last 10 seconds will be replaced by the count down.

ℓℓr Auto reclosing time after transit

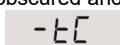
If in the opening phase or in the completely open position the beam of the photocells is obscured and freed, the gate automatically closes after ℓℓr seconds when the completely open position is reached. In this phase the display shows  with the blinking dash, that during the last 10 seconds will be replaced by the count down.

5Eℓ Obstacle sensitivity

Adjust the obstacle sensitivity to ensure a correct functioning of the gate, it must stop if there is an obstacle but also it must ensure the complete movement in the worst conditions (exp. winter, hardening of motors, etc). After the adjustment of this parameter it is recommended to perform a complete movimentation (opening and closing) before trying the obstacle detection. The intervention of the obstacle sensitivity stops the gate and makes a short inversion of the movement.

ℓr9 Motor torque

Adjust the motor torque to ensure a correct functioning of the gate, it is possible to adjust the percentage of torque between 10% to 100%. After the adjustment of this parameter it is recommended to perform a complete movimentation (opening and closing) to ensure a correct functioning of the gate.

55ℓ Slowing down mode

The control unit has 2 different type of slowing downs : standard or with higher torque and speed, for heavier gates.

5b5 Step by step configuration (SS)

- 5b5 = 0 Normal (OP-ST-CL-ST-OP-ST...)
Typical functioning of Step by Step. During the movement a SS command stops the gate.
- 5b5 = 1 Alternated STOP (OP-ST-CL-OP-ST-CL...)
Alternated functioning with STOP during the opening. During the opening phase a SS command stops the gate.
- 5b5 = 2 Alternated (OP-CL-OP-CL...)
The user cannot stop the gate during the movement with a SS command.
A SS command during the movement inverts the movement.
- 5b5 = 3 Condominium – timer
A SS command only opens the gate. When the gate is completely open, if the command persist the control unit will wait until the opening of the contact before beginning the countdown of the automatic reclosing (if enabled), another SS command in this phase will restart the countdown of the automatic reclosing.
- 5b5 = 4 Condominium with immediate auto reclosing
Like condominium – timer (previous point) but during the countdown a SS command will close the gate.

bℓℓ After black-out

When the control unit turns on after a black-out,

- bℓℓ = 0 No action – when the control unit turns on the gate doesn't move until the first command, the first movement is a slow opening.
- bℓℓ = 1 Closing– turning on the control unit it will perform a slow closing.

* 55ℓ Soft start

The movement begins with reduced torque, used in light gates.

* ℓ5ℓ Amplitude of slowing down

With this parameter it is possible to adjust the amplitude of the slowing down and eventually disable it (ℓ5ℓ = 0). If you need more precise or different slowing down between opening and closing it is possible to set the parameter ℓ5ℓ on P (personalized) and perform an advanced learning of strokes (5.2) providing also the beginning of slowing downs during the learning.

5ℓr Deceleration ramp amplitude

With this parameter it is possible to define the amplitude of the deceleration ramp and possibly its exclusion (5ℓr = 0).

It allows performing a deceleration from cruising speed to the retarding speed, more or less evident depending on the installation requirements.



***ATTENTION!**

It is not advisable the disabling of the slowing downs and, if possible, use the "soft start" function.

6.3.2 Advanced menu

5i.d. Bluetooth

Item of the menu needed to the first coupling between an Android device and the control unit. Refer to the Help of the Android application for the connection procedure.

EL.F. Electrical brake

Short reverse movement with reduced torque to reduce the inertia of the gate. The operation is performed at each stop of the movement except for fast movement after the intervention of a safety devices.

5P.h. Functioning of closing photocell PHOTO1 moving from closed position

The closing photocell has the following functioning

- Closing: immediate inversion of movement
- Opening from an intermediate position: no intervention
- Opening from closed position:
 - ◆ $5P.h. = 0$ The gate doesn't move if PHOTO1 beam is cut
 - ◆ $5P.h. = 1$ The gate moves while PHOTO1 beam is cut

Ph.2. Functioning of opening photocell PHOTO2

The opening photocell has the following functioning

- Opening: stops the movement and waits until the beam is freed, then moves in opening.
- Closing:
 - ◆ $Ph.2. = 0$ Stops the movement and waits until the beam is freed, then moves in opening
 - ◆ $Ph.2. = 1$ No intervention

EP.h. Photocells test

Enabling this function, before each movement starting from still gate, the control unit performs a functional check of the photocells. The check will not be performed in case of fast movement after the intervention of a safety devices. Follow paragraph 3.6 for the connections of the photocells.

Ed.i. Safety edge type

The control unit can work with two different type of safety edge:

- $Ed.i. = 0$ Mechanical with normally closed contact
- $Ed.i. = 1$ Resistive 8k2

iE.d. Operation mode of safety edge

To allow the installation of the safety edges in both the directions of movements, it is possible to choose 2 different functioning:

- $iE.d. = 0$ Only in closing with total inversion of movement
- $iE.d. = 1$ Both directions of movements, stop and short inversion to free the obstacle

EE.d. Safety edge test

Enabling this function the control unit performs a functional check of the safety edge. This function is used if the edge connected to the control unit has an electronic self test (exp. radio edge R.CO.O). Connect the test contact of the edge to the power supply of the transmitter of the photocells (paragraph 3.6) and enable the self test with low voltage 0Vdc (for the compatibility follow the instruction of the manual of the safety edge).

LP.o. Partial opening

Partial opening can be performed only starting from closed. The parameter sets the opening like a percentage of the total stroke of the first wing.

tP.L. Auto reclosing time from partial opening

Active when the gate is in the partial opening, the gate automatically closes after $tP.L.$ seconds. In this phase the display shows with the blinking dash, that during the last 10 seconds will be replaced by the count down.

-tP

FP.r. Flashing light output mode

It is possible to choose 2 different functioning for the blinker output:

- $FP.r. = 0$ Fixed blinker output. It will be necessary to connect a self flashing blinker (B.RO LIGHT 230 Vac)
- $FP.r. = 1$ Flashing light blinker output. It will be necessary to connect a fix light blinker (B.RO LIGHT FIX 230 Vac)

tP.r. Pre-flashing time

Pre-flashing before each movement in both directions, $tP.r.$ seconds of pre-flashing

FC.Y. Courtesy light settings

The control unit has 4 different functionings for courtesy light:

- $FC.Y. = 0$ the light switches off at the end of a movement after $tC.Y.$ seconds
- $FC.Y. = 1$ the light switches off only with closed gate after $tC.Y.$ seconds
- $FC.Y. = 2$ lighted on for $tC.Y.$ seconds from the beginning of a movement, independently of the condition of the gate
(the light could switch off before the end of movement)
- $FC.Y. = 3$ open gate light - the light switches off immediately when the gate reaches the closed position
- $FC.Y. = 4$ open gate light with proportional blinking:
 - ◆ opening – slow blinking
 - ◆ closing – fast blinking
 - ◆ opened – light on
 - ◆ closed – light off
 - ◆ stopped – 2flash + long wait + 2flash + long wait + ...

tC.Y. Courtesy light timer

Courtesy light activation timer

dE.A. Dead man

During dead man functioning mode the gate moves only with a permanent command. The enabled commands are OPEN and CLOSE. SS and PED are disabled. During dead man functioning all the automatic movements are disabled, like short or total inversions. All safety devices are disabled except for STOP.

5E.r. Setting threshold of cycles for assistance request

It is possible to set a number of cycles before the request of assistance. Once the limit is reached the next cycles will be done with fast blinking (only if FPr enabled)

5E.F. Continuous flashing light for assistance request

Once limit 5E.r. is reached the flashing light will blink also with the gate closed to show the request of assistance.

Er.5. Viewing of the memory position for a single transmitter

With the item of the menu Er.5. it is possible to view the memory location in which a transmitter is memorized.

To perform the function, move to Er.5. and then confirm by pressing the button MENU. Keep pressed MENU button until the display will show **SEE** then release the button.

At this point press a button of the memorized transmitter (it does not active any command). The display shows:

- the memory location for 2 seconds, if is memorized;
- the written **not** for 2 seconds, if is not memorized.

After 2 seconds the display returns to the screen **SEE** and it will be possible to perform this function with another transmitter.

To exit from the function, press MENU button. Otherwise after 15 seconds without transmission, the control unit exits from the function and shows the written

toUt

Er.L. Cancellation of a single transmitter

With the item of the menu Er.L. it is possible to delete a single transmitter from the memory.

To perform the function, move to Er.L. and then confirm by pressing the button MENU. Keep pressed MENU button until the display will show 0, then release the button. Select the memory location of the transmitter. Press and keep pressed MENU button until the display will show **CLr**, then release the button.

To exit from the function, press MENU button. If the display shows the written **Err**, there are problems with the memory (for example empty position or disconnected memory).

dE.F. Restore default settings

With this parameter it is possible to restore the default settings of the control unit. The reset will restore all the parameters of the base and advanced menu, but doesn't modify the learnt strokes, the directions of motors and the transmitters.

Move to dE.F. then keep pressed MENU button until the display shows 0, release the button. Press again and keep pressed MENU button, the display will show a count down **d80,d79,...,d0 !**, don't release the button until the display shows

don

Er.F. Erasing of all transmitters

With this parameter it is possible to erase all the transmitters learnt.

Move to Er.F. then keep pressed MENU button until the display shows 0, release the button. Press again and keep pressed MENU button, the display will show a count down **d80,d79,...,d0 !**, don't release the button until the display shows

don

7. Display and control unit state

7.1 Input LED and safety devices

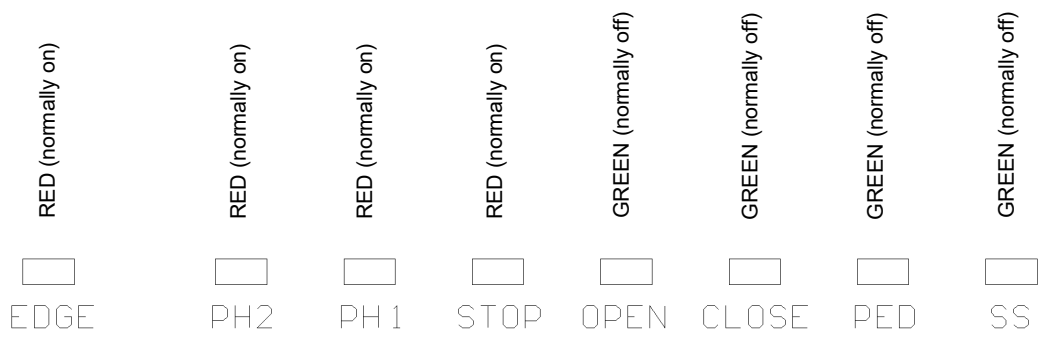

7.2 Normal functioning:

| | |
|------|--|
| -- | Standby - Gate closed or after the switch on of the control unit |
| OP | Opening phase |
| CL | Closing phase |
| SO | Gate closed by user during opening |
| SC | Gate closed by user during closing |
| HA | Gate stopped by an external event (photocells, stop) |
| oP | Gate opened without automatic reclosing |
| PE | Gate opened in partial opening position without automatic reclosing |
| -tC | Gate opened waiting for auto reclosing, last 10 seconds the dash will be replaced by the countdown |
| -tP | Gate opened in partial opening position waiting for auto reclosing, last 10 seconds the dash will be replaced by the countdown |
| 000 | During the normal functioning and out from any menu, the pression of the DOWN[-] button lets you see the number of cycles done, you will see units with dots on the bottom of display and thousand without dot, another pression of DOWN[-] or MENU button let you to leave the cycles visualization |
| 000 | |
| rAd | Visualized during the learning of transmitters |
| don | Visualized when memorized a new transmitter or at the and of a reset |
| Fnd | Visualized when memorized a button of a transmitter already memorized |
| CLr | Visualized when a trasmitter is erased |
| LOP | Visualized during the learnign of strokes to indicate that the control unit is opening the gate and waiting for the command of opening mechanical stop |
| LCL | Visualized during the learning of strokes to indicate that the control unit is clkosign the gate and waiting for the command of closing mechanical stop |
| L-- | Visualized during the learning of strokes if there is an intervention of safety devices |
| SEE | Visualized when the control unit waits a transmitter signal, during the function of viewing of the memory location. |
| not | Visualized when the transmitter is not stored on the memory, during the function of viewing of the memory location. |
| toUt | Visualized when the control unit exits from the function of viewing of the memory location for inactivity. |
| Snd | Visualized during the first coupling with the Bluetooth device. |
| c -- | Visualized when the control unit is connected to a Bluetooth device |
| L -- | Visualized when Bluetooth device is disconnecting from the control unit. |

7.3 Errors:

| | |
|-----|---|
| EFO | Impact sensor intervention |
| EEd | Safety edge intervention |
| ELS | Limit switches error (both opening and closing electrical limit switches busy in the same time) |
| EPH | Malfunctioning of photocells |
| Eth | Thermal intervention to preserve the control unit |
| EiE | Memory error |
| FUL | Full memory |
| Err | Memory error during functions viewing memory location or cancellation of a single transmitter |

The visualization of an error on the display persist until another command is given

8. Technical features**POWER SUPPLY AND CONSUMPTION**

| | |
|---|--------------------|
| Power supply voltage | 230 Vac - 50/60 Hz |
| Absorption from line (Standby) | 45 mA @ 230 Vac |
| Standard configuration (2 couple of photocells, RX radio safety edge) | |
| Line fuse | F6.3A |

MOTOR POWER SUPPLY

| | |
|------------------------------------|--------------------|
| Number of motors | 1 |
| Motor power supply voltage | 230 Vac - 50/60 Hz |
| Maximum power absorbed from motors | 700W |

ACCESSORIES POWER SUPPLY

| | |
|---|------------------|
| Accessories power supply voltage | 24 Vdc |
| Maximum current absorbed from accessories | 170 mA |
| Maximum power absorbed from accessories | 4 W |
| Accessories fuse | F 0.5 A |
| Blinker output | 230 Vac 60W max |
| Courtesy light output / open gate light | 230 Vac 100W max |

FUNCTIONALITY

| | |
|------------------------|-------------------|
| 433 MHz radio receiver | Rolling code |
| Maximum transmitters | 1000 (up to 8000) |
| Safety edge input | NC / 8k2 |

DISPOSAL OF THE PRODUCT

This product is an integral part of the automation, and therefore, they must be disposed of together. As for the installation operations, at the end of the life of this product, the dismantling operations must be performed by qualified personnel. This product is made from different types of materials: some can be recycled, others must be disposed of. Please inform yourselves on the recycling or disposal systems provided for by the laws in force in your area, for this category of product.

CAUTION! – some parts of the product can contain polluting or dangerous substances which, if dispersed in the environment, may cause serious harm to the environment and human health.

As indicated by the symbol at the side, it is forbidden to throw this product into domestic refuse. Therefore, follow the “separated collection” instructions for disposal, according to the methods provided for by local regulations in force, or redeliver the product to the retailer at the moment of purchase of a new, equivalent product.

CAUTION! – the regulations in force at local level may envisage heavy sanctions in case of abusive disposal of this product.

GUARANTEE - In compliance with legislation, the manufacturer's guarantee is valid from the date stamped on the product and is restricted to the repair or free replacement of the parts accepted by the manufacturer as being defective due to poor quality materials or manufacturing defects. The guarantee does not cover damage or defects caused by external agents, faulty maintenance, overloading, natural wear and tear, choice of incorrect product, assembly errors, or any other cause not imputable to the manufacturer. Products that have been misused will not be guaranteed or repaired. Printed specifications are only indicative. The manufacturer does not accept any responsibility for range reductions or malfunctions caused by environmental interference. The manufacturer's responsibility for damage caused to persons resulting from accidents of any nature caused by our defective products, are only those responsibilities that come under Italian law.



ALLMATIC S.r.l
 32026 Borgo Valbelluna - Belluno – Italy
 Via dell'Artigiano, n°1 – Z.A.
 Tel. 0437 751175 – 751163 r.a.
<http://www.allmatic.com>
 E-mail: info@allmatic.com